

NUOMI 诺米

NUOMI 诺米

Four Seasons (Guangzhou) Home Building Materials Co., Ltd.

Add: No. 27-28, Yancheng Decorating Material Market, Nan'an Road.
Liwan Distric, Guangzhou, China
Contact: Sasa +8615817178181 / Linda +8618675011174
Web: <http://fshome.en.alibaba.com>
Email: Linda@fsgzhome.com



公众号



服务号

NUOMI 诺米



KITCHEN STORAGE SOLUTIONS

诺米厨房五金收纳解决方案

NUOMI KITCHEN
STORAGE SOLUTIONS

诺米厨房五金收纳解决方案



NUOMI 诺米



NUOMI IS COMMITTED TO ACHIEVING A PERFECT QUALITY OF LIFE!

诺米，致力于实现完美品质生活！

诺米作为优秀的功能五金缔造者，提供的不仅仅是产品与服务，而是对梦想生活的执着！为了赋予居家生活更加优越的功能性、舒适性和美观性。品牌将原创美学设计与智能科技完美地结合在一起，设计出独具特色的功能五金系统。为消费者打造完美品质生活。

As an excellent functional hardware creator, Nuomi not only provides products and services, but the persistence of the dream of life, in order to endow the home life with more superior functions, comfort and beauty. The brand perfectly combines the original aesthetic design with the intelligent technology to design a unique functional hardware system, so to create a perfect quality of life for consumers.

在诺米的世界里，创新永无止境，对品质的苛刻要求成就了诺米卓越的品牌形象。我们以安全、可靠的产品质量对顾客承担责任。坚持为顾客提供高品质产品、高标准服务，为推进品质生活的不断发展，我们一直努力前行。我们主张在顾客、员工、合作者和公司之间结成利益共同体，并力图让顾客满意、员工满意、合作者满意。

In the world of Nuomi, innovation is endless, and the demanding requirements on quality make Nuomi an excellent brand image. We are responsible to our customers with the safe and reliable product quality. We insist on providing high quality products and high standard services for our customers. In order to promote the continuous development of quality life, we have been making great efforts to move forward. We advocate a community of interests among customers, employees, partners and the company, and strive to make the customers, employees and partners satisfied.

未来，诺米将不断创新，创造更多颠覆性的设计。从设计、品质到服务，不断提升诺米的品牌价值，打造国际领军品牌。让人们在品味产品的同时更感受着来自品牌的自豪与荣耀。诺米，功能五金创新引领者，行业标准重塑者，颠覆传统生活，开创完美生活N次方时代！

In the future, Nuomi will continue to innovate and create more disruptive designs. From the design, quality to service, the company will constantly enhance the brand value of Nuomi, and create an international leading brand, which enable people to feel the pride and glory from the brand while tasting the products at the same time. Nuomi, the function hardware innovation leader and the industrial standard remodeler, subvert the traditional life and create a perfect life of N times!

NUOMI KITCHEN
STORAGE SOLUTIONS



NUOMI DATA - 诺米数字

0.01

0.01cm 精控误差, 追求卓越品质的产品契合
0.01 cm precision control, pursue excellent product quality

3

3 重国际权威品质认证: 英国 ISO 9001, 瑞士 SGS, 德国 TÜV
Quality Certificate from International Authority: ISO 9001, SGS, TÜV

7

7 级质检把控, 从原料到成品
每一件产品历经层层检测
7 levels strict quality control. From raw material to finished product, every product pass through strict detection.

10

导轨 10 年至终身质量保障, 让用户时刻无忧
Slide 10 years to lifelong quality guarantee, makes users worry-free about quality and after-sales service.

168

核心产品采用纳米干镀表面处理技术, 通过 SGS
168 小时中性盐雾测试, 超强防锈
Dry plating technology of surface treatment for core products passes SGS 168 hours salty spray test, super rust-resistant.

80000

SGS 80000 次抗疲劳运作测试, 安心更舒心
SGS 80000 cycles movement test, guarantee longer service life.







INDEX - 目录

魅影系列
ENCANTO
P.009

紫水晶系列
AMETHYST
P.097

特拉斯系列
TERRAS
P.141

香槟玫瑰系列
CHAMPAGNE ROSE
P.179

金刚系列
DEVARAJAS
P.221

伯爵 X 系列
VISCOUNT-X
P.261

配套产品
OTHER KITCHEN STORAGE
PRODUCT
P.273

ENCANTO

魅影系列







CHAMPAGNE GOLD AND HIGH-CLASS GREY, MINIMALIST COLOR

香槟金与太郎灰, 诠释极简轻奢色彩

To meet your individual needs, champagne gold, High-class grey is always the most popular color, amazing appearance, following the current fashion trend.

满足您的个性需求, 香槟金, 太郎灰一直是极简设计风格所热捧的色调, 颜值惊艳, 顺应现时家居生活潮流。

CHAMPAGNE GOLD 香槟金

There is no place for light luxury sense, produce different visual tension.

无处安放的轻奢感,
产生不一样的视觉张力。



HIGHCLASS GREY 太郎灰

Extremely low-key, but everywhere revealed the benefits of the high-level sense.

低调至极, 却又处处透着
恰到好处的高级感。



CORNER UNITS

转角系统



Little monster series, make full use of kitchen corner space, realize all articles pull out Cabinet width body, although face the thing inside most, also can easily access.

转角小怪物，充分利用厨房转角空间，实现所有物品拉出柜体，即使面对最里面的物件，也可轻松存取。

NUOMI KITCHEN STORAGE SOLUTIONS

The fashionable art design, the constantly evolving production technology and the hidden essential function only love you who know how to enjoy life, let you leisurely enjoy the art life.

时尚的艺术设计，不断演进的制作工艺与潜藏的实质功能，只钟情于懂得享受生活的您，让您从容享受艺术生活。





Function 功能

Make full use of corner space,improve space utilization rate,the inner basket can be pulled out completely,convenient to fetch items.

提升空间利用率充分利用橱柜转角位置空间，一次性把转角篮的所有物品带到柜门外，收纳物品存取方便。

Quality 品质

Sides of basket is made of superior aviation aluminium alloy,advanced fluorocarbon coating surface treatment technology, strong ,rust resistance,abrasive resistance. The linkage structure is made of premium steel, European standard environmental surface treatment technology, running smooth and stable.

篮子边框选用优质航空级铝合金，表面采用精湛氟碳喷涂工艺，保证防腐防锈，耐磨防刮，久用如新，质感卓越；联动框架选用优质钢材，表面经过欧标环保工艺处理，联动结构运动顺滑、流畅，完美开合。

Design 设计

Two color options,Champagne Gold and Highclass Grey. Slim sides design, interpreting minimalism and light luxury style, enhance the taste of kitchen storage. The bottom is covered by non-slip mat,prevent the items from collision,and convenient to clean at the same time.

香槟金和太师灰两种色彩选择，纤薄板式围边，完美诠释家居极简轻奢风格，使厨房收纳空间更加优雅有品位；底板防滑垫应用，防止运动过程中物品的碰撞以及噪声，同时方便清洁。

Storage 储物

It is recommended to store less-commonly-used small household appliances, like pots, plates, dishes, dried fruit and so on.

建议储存相对不常用的小家电、锅盘碗碟、干货等。

Loading Capacity 承重

Max load of each bigger basket is 5KG, Max load of each smaller basket is 3KG

每个大篮最大承重 5KG，每个小篮最大承重 3KG。

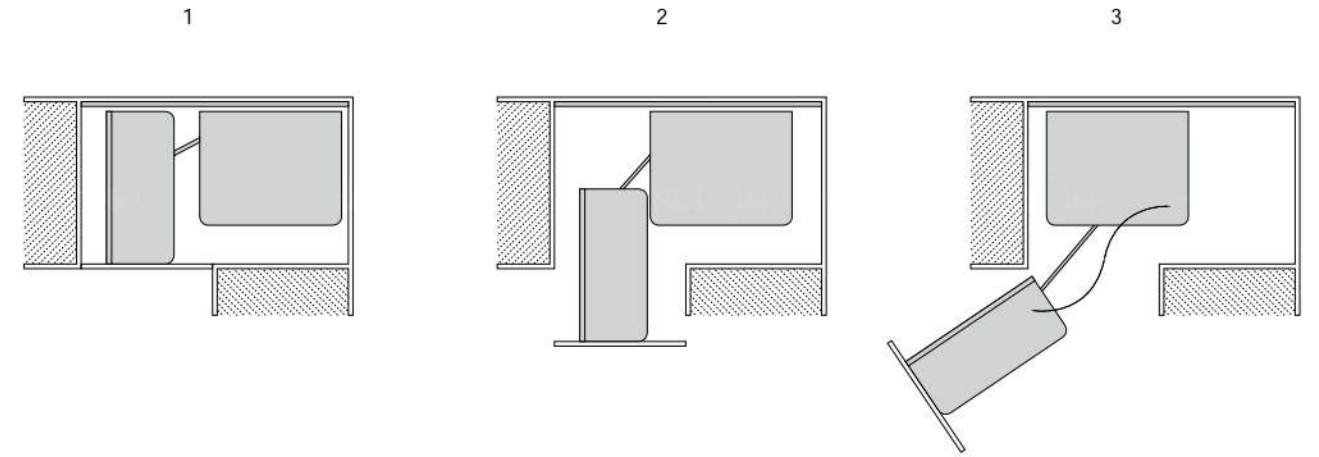

Storage Capacity 收纳展示



Make full use of corner position, split the design that moves continuously, can pull whole basket to give Cabinet width body, go to the lavatory greatly store content. In the left corner or right corner can be installed.

充分利用转角位置，分体连动的的设计，可把全部篮子拉出柜体，极大方便储物。在左开转角或右开转角中均可安装。



ENCANTO MAGIC CORNER 魅影小怪物



支架型号 Frame item No.	篮体型号 Basket item No.	适用柜宽 (T) Cabinet width	规格 (长 x 宽 x 高) Width x Depth x Height	描述 Description		
香槟金 Champagne gold	太郎灰 Highclass grey	香槟金 Champagne gold	太郎灰 Highclass grey			
1010001C	1010001B	1010170	1010180	900-1000mm	(860-960)x530x520mm	左开 /Left open
1010002C	1010002B	1010170	1010180	900-1000mm	(860-960)x530x520mm	右开 /Right open

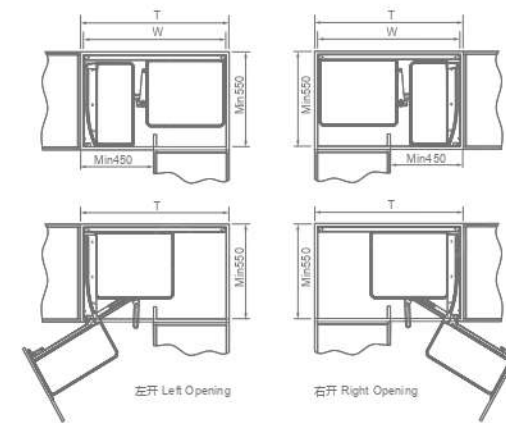



ENCANTO REVOLVING SAUCER 魅影阻尼飞碟



型号 Item No.	适用柜宽 (T) Cabinet width	宽度 x 深度 x 高度 Width x Depth x Height	材质 Material	表面处理 Surface treatment	描述 Description
香槟金 Champagne gold	太郎灰 Highclass grey				
1020061	1020071	900mm	830x500x(620-720)mm	铝合金 /Aluminium	氟碳喷涂 /Fluorocarbon coating
1020062	1020072	900mm	830x500x(620-720)mm	铝合金 /Aluminium	氟碳喷涂 /Fluorocarbon coating

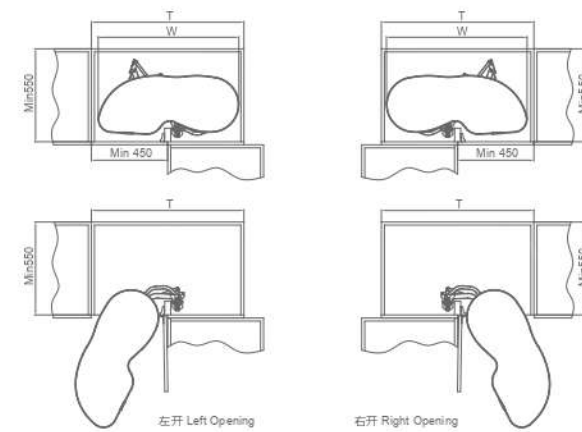



ENCANTO 180°TURNTABLE SHELF 魅影 180°转盘



型号 Item No.	适用柜宽 (T) Cabinet width	宽度 x 深度 x 高度 Width x Depth x Height	材质 Material	表面处理 Surface treatment
香槟金 Champagne gold	太郎灰 Highclass grey			
1030062	1030072	900mm	铝合金 / Aluminium	氟碳喷涂 / Fluorocarbon coating

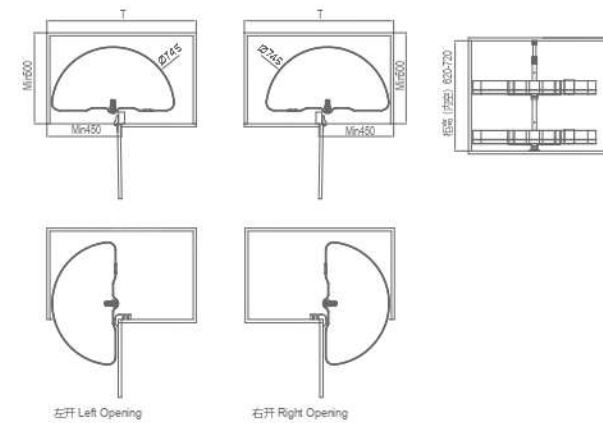



ENCANTO 270°TURNTABLE SHELF 魅影 270°转盘



型号 Item No.	适用柜宽 (T) Cabinet width	宽度 x 深度 x 高度 Width x Depth x Height	材质 Material	表面处理 Surface treatment
香槟金 Champagne gold	太郎灰 Highclass grey			
1030061	1030071	900mm	铝合金 / Aluminium	氟碳喷涂 / Fluorocarbon coating

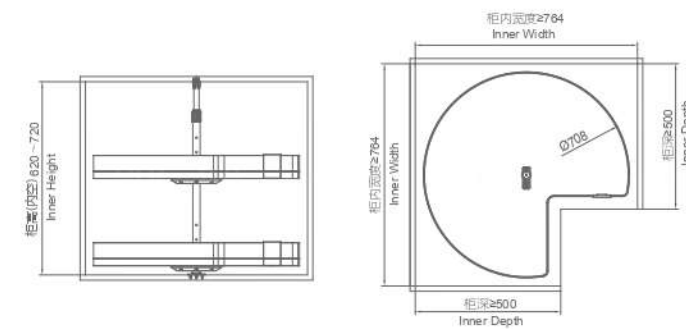

AIRCRAFT CARRIER CABIN

魅影航母台

Unique linkage design, open the door at the same time with all the baskets, convenient storage. Mute design, so that the product in the process of opening and closing, always maintain a smooth and smooth effect. Double guide rail design, a change of the previous single guide rail mode, strengthen the bearing capacity of the product, and make the pull out to maintain a stable.

独特的联动设计，在开门的同时带出全部篮子，方便存放物品。静音设计，使产品在开合过程中，始终保持平稳、顺畅的效果。双导轨设计，一改以往单导轨模式，强化产品的承载能力，并使拉出保持平稳。





Function 功能

German technology, super load-bearing damping, fully pull-out guide rail, cabinet door is suggested being amounted with 165° hinge, product can be completely pulled out. Mounting height of basket can be adjusted flexibly, convenient to store items. The basket is quadrate design, extraordinary capacity

融合德国技术的超强承重大型阻尼全拉出导轨，与 165° 铰链配合安装，可将产品全拉出柜身；篮子安装高度可灵活调节，极大方便存取物品；篮子方正宽阔，贮量巨大。

Quality 品质

Sides of basket is made of superior aviation aluminium alloy, advanced fluorocarbon coating surface treatment technology, strong, rust resistance, abrasive resistance. The linkage structure is made of premium steel, European standard environmental surface treatment technology, running smooth and stable.

篮子边框选用优质航空级铝合金，表面采用精湛氟碳喷涂工艺，保证防腐防锈，耐磨防刮，久用如新，质感卓越；联动框架选用优质钢材，表面经过欧标环保工艺处理，联动结构运动顺滑、流畅，完美开合。

Design 设计

Two color options, Champagne Gold and Highclass Grey. Slim sides design, interpreting minimalism and light luxury style, enhance the taste of kitchen storage. The bottom is covered by non-slip mat, prevent the items from collision, and convenient to clean at the same time.

香槟金和太师灰两种色彩选择，纤薄板式围边，完美诠释家居极简轻奢风格，使厨房收纳空间更加优雅有品位；底板防滑垫应用，防止运动过程中物品的碰撞以及噪声，同时方便清洁。

Storage 储物

It is recommended to store frequently-used kitchen utensils, snacks, dried fruit or condiments. It is suitable to be used with embedded refrigerator in high cabinet combination, not only can convenient to fetch items, but also can reduce the abrupt feeling of single use.

建议储存常用的厨房器皿、零食、干果或调味品；适合设计在高柜组合中与内嵌式冰箱搭配使用，既方便物品的存取和转移，又能避免单独使用产生的突兀感。

Loading Capacity 承重

Total Max loading 75KG, each basket Max loading 15KG.

整套最大承重 75KG，每个篮最大承重 15KG。

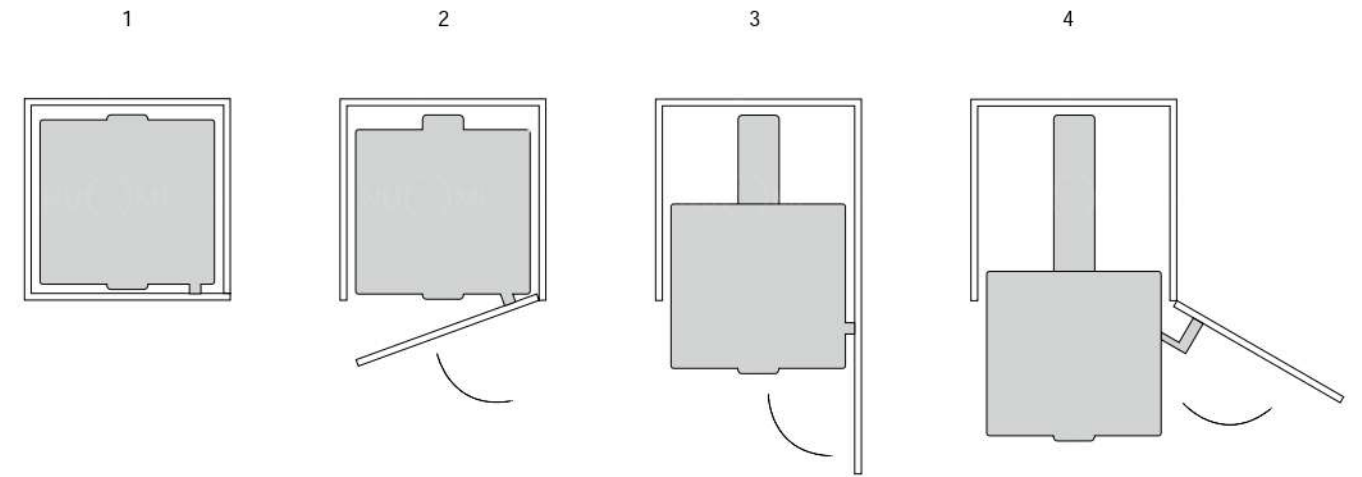

Storage Capacity 收纳展示



Function and daily practical perfect union, through confluence all sorts of contradictions, create a real special work: which is suitable for kitchen to store all kinds of articles.

功能与日常实用性完美结合，通过融合各种矛盾，创造出真正的非凡之作：一款适合厨房收纳各种物品的性能强大的功能五金。



ENCANTO AIRCRAFT CARRIER CABIN 魅影航母台



支架型号 Frame item No.	篮体型号 Basket item No.	适用柜宽 (T) Cabinet width	规格 (长 x 宽 x 高) Width x Depth x Height	描述 Description		
香槟金 Champagne gold	太郎灰 Highclass grey	香槟金 Champagne gold	太郎灰 Highclass grey			
2030001C	2030001B	2030171	2030181	450mm	(404-424)x500x1430mm	4层 /Tiers
2030001C	2030001B	2030173	2030183	600mm	(554-574)x500x1430mm	4层 /Tiers
2030002C	2030002B	2030172	2030182	450mm	(404-424)x500x1780mm	5层 /Tiers
2030002C	2030002B	2030174	2030184	600mm	(554-574)x500x1780mm	5层 /Tiers

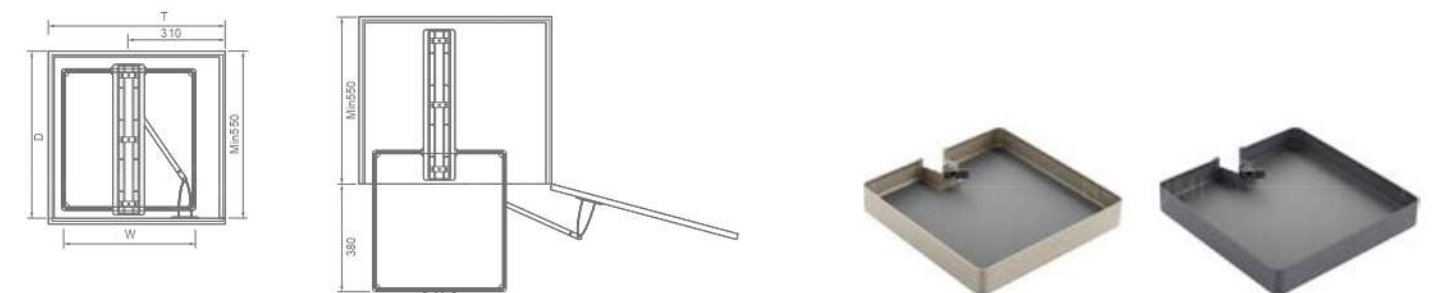

建议门板使用 165° 铰链
Suggesting cabinet door being mounted with 165° hinge

PANTRY ROLL-OUT

魅影大怪物



Slim sides design, interpreting minimalism and light luxury style, enhance the taste of kitchen storage. The bottom is covered by non-slip mat, prevent the items from collision, and convenient to clean at the same time.

纤薄板式围边，完美诠释家居极简轻奢风格，使厨房收纳空间更加优雅有品位；底板防滑垫应用，防止运动过程中物品的碰撞以及噪声，同时方便清洁。



Function 功能

German technology, super load-bearing, widen roller structure guide rail, simple and brand new linkage structure, pull out the inner baskets while opening the door. Load-bearing point of cabinet door focus on bottom of cabinet, protect the door from deformation.

融合德国技术的超强承重滚轮结构轨道，整体框架采用新型联动结构，合理分割横向空间，开门同时联动内部篮子滑动至你的面前，物品一目了然。柜门挂篮承重点设计在柜体底部，保护柜门不会因承重变形。触手可及，存取方便。

Quality 品质

Sides of basket is made of superior aviation aluminium alloy, advanced fluorocarbon coating surface treatment technology, strong, rust resistance, abrasive resistance. The linkage structure is made of premium steel, European standard environmental surface treatment technology, running smooth and stable.

篮子边框选用优质航空铝合金，表面采用精湛氟碳喷涂工艺，保证防腐防锈，耐磨防刮，久用如新，质感卓越；联动框架选用优质钢材，表面经过欧标环保工艺处理，联动结构运动顺滑、流畅，完美开合。

Design 设计

Two color options, Champagne Gold and Highclass Grey. Slim sides design, interpreting minimalism and light luxury style, enhance the taste of kitchen storage. The bottom is covered by non-slip mat, prevent the items from collision, and convenient to clean at the same time.

香槟金和太灰两种色彩选择，纤薄板式围边，完美诠释家居极简轻奢风格，使厨房收纳空间更加优雅有品位；底板防滑垫应用，防止运动过程中物品的碰撞以及噪声，同时方便清洁。

Storage 储物

It is recommended to store frequently-used kitchen utensils, snacks, dried fruit or condiments. It is suitable to be used with embedded refrigerator in high cabinet combination, not only can convenient to fetch items, but also can reduce the abrupt feeling of single use.

建议储存常用的厨房器皿、零食、干果或调味品；适合设计在高柜组合中与内嵌式冰箱搭配使用，既方便物品的存取和转移，又能避免单独使用产生的突兀感。

Loading Capacity 承重

Max loading for each bigger basket 5KG, Max loading for each smaller basket 3KG.

每个大篮最大承重 5KG，每个小篮最大承重 3KG。

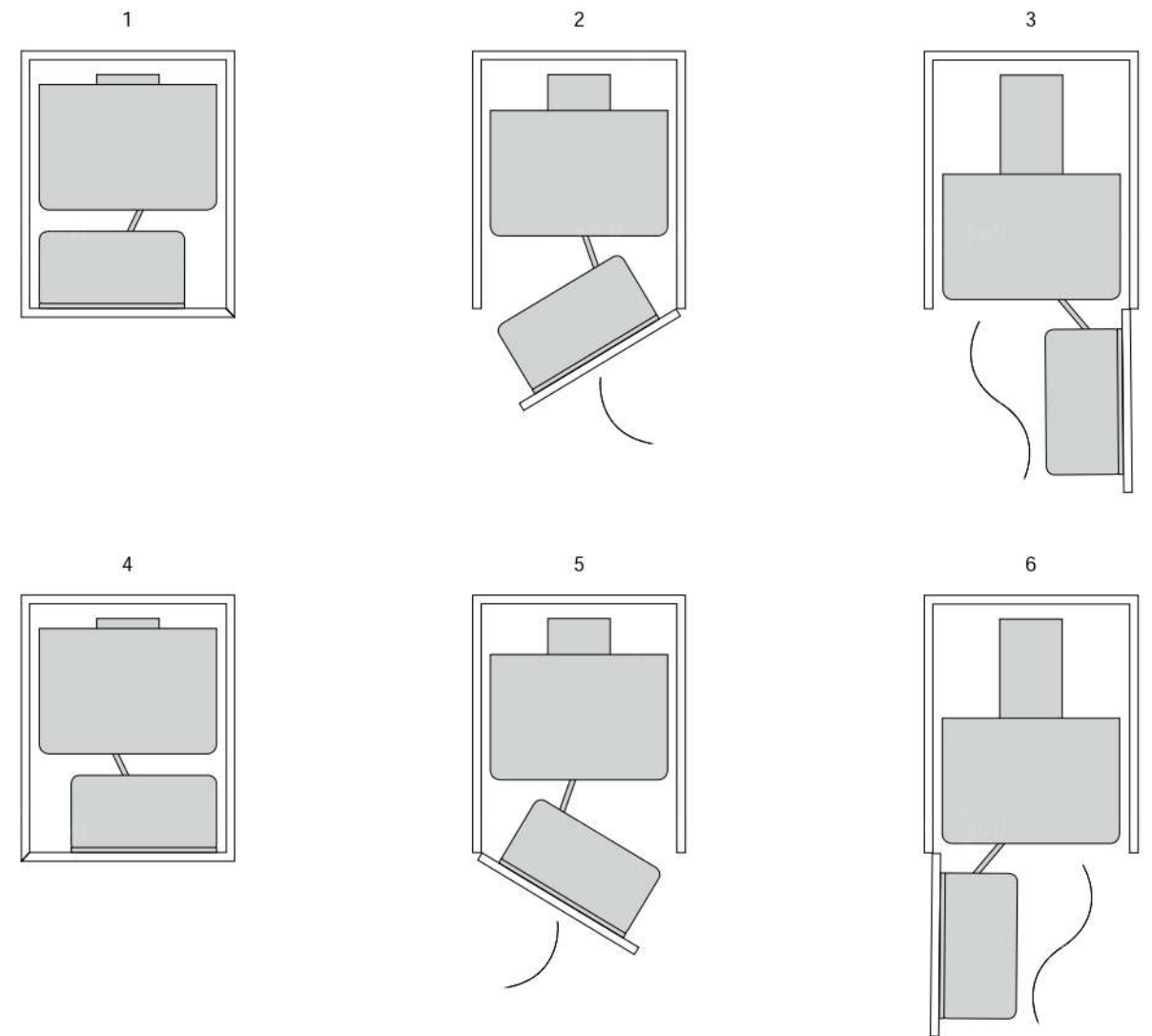

Storage Capacity 收纳展示



Function and daily practical perfect union, through confluence all sorts of contradictions, create a real special work: a suit the kitchen receives the functional hardware with the powerful performance of all sorts of articles.

功能与日常实用性完美结合，通过融合各种矛盾，创造出真正的非凡之作；一款适合厨房收纳各种物品的性能强大的功能五金。



PANTRY ROLL-OUT 魅影大怪物



支架型号 Frame Item No.	篮体型号 Basket Item No.	适用柜宽 (T) Cabinet width	规格 (长 x 宽 x 高) Width x Depth x Height	描述 Description		
香槟金 Champagne gold	太郎灰 Highclass grey	香槟金 Champagne gold	太郎灰 Highclass grey			
2020001C	2020001B	2020171	2020181	450mm	405x500x(1180 以上 above)mm	4层 /Tiers
2020002C	2020002B	2020172	2020182	450mm	405x500x(1430 以上 above)mm	5层 /Tiers
2020003C	2020003B	2020173	2020183	450mm	405x500x(1780 以上 above)mm	6层 /Tiers
2020004C	2020004B	2020174	2020184	600mm	555x500x(1180 以上 above)mm	4层 /Tiers
2020005C	2020005B	2020175	2020185	600mm	555x500x(1430 以上 above)mm	5层 /Tiers
2020006C	2020006B	2020176	2020186	600mm	555x500x(1780 以上 above)mm	6层 /Tiers

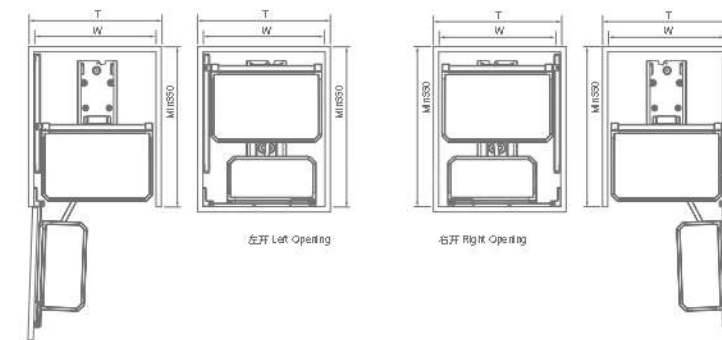

TALL UNIT

魅影阻尼旋转高身篮



Heavy damping rail technology is also the key to achieve running function of the tall Cabinet width, especially under heavy loading weight reflecting the perfect balance of supporting capacity and storage function.

重型阻尼导轨技术也是实现高柜功能的关键，尤其在承重量达到相当程度的前提下，整体顺滑拉出时，重型阻尼技术都为使用者提供绝佳的功能保障，体现了支撑能力与收纳功能的完美平衡。



Simple design, the perfect combination of beauty and storage function, make your dream kitchen.
去繁就简，窥见生活简练一面。美观与储物完美结合，让梦想厨房更贴近您的生活。



Function 功能

German technology super load-bearing damping guide rail, synchronization damping design of upper and bottom guide rails, running smooth and stable. Mounting height of basket can be adjusted flexibly, extraordinary capacity. Unique 180° rotatable structure, convenient to store items.

融合德国技术的超强承重大型阻尼全拉出导轨，上下轨同步阻尼设计，推拉顺滑、平稳、静谧。贮容巨大，篮子安装高度可灵活调节，独创 180° 左右旋转功能结构，极大方便存取物品。

Quality 品质

Sides of basket is made of superior aluminium alloy, advanced fluorocarbon coating surface treatment technology, strong, rust resistance, abrasive resistance. The linkage structure is made of premium steel, European standard environmental surface treatment technology, running smooth and stable.

篮子边框选用优质航空级铝合金，表面采用精湛氟碳喷涂工艺，保证防腐防锈，耐磨防刮，久用如新，质感卓越；联动框架选用优质钢材，表面经过欧标环保工艺处理，联动结构运动顺滑、流畅，完美开合。

Design 设计

Two color options, Champagne Gold and Highclass Grey. Slim sides design, interpreting minimalism and light luxury style, enhance the taste of kitchen storage. The bottom is covered by non-slip mat, prevent the items from collision, and convenient to clean at the same time.

香槟金和太师灰两种色彩选择，纤薄板式围边，完美诠释家居极简轻奢风格，使厨房收纳空间更加优雅有品位；底板防滑垫应用，防止运动过程中物品的碰撞以及噪声，同时方便清洁。

Storage 储物

It is recommended to store frequently-used kitchen utensils, snacks, dried fruit or condiments. It is suitable to be used with embedded refrigerator in high cabinet combination, not only can convenient to fetch items, but also can reduce the abrupt feeling of single use.

建议储存常用的厨房器皿、零食、干果或调味品；适合设计在高柜组合中与内嵌式冰箱搭配使用，既方便物品的存取和转移，又能避免单独使用产生的突兀感。

Loading Capacity 承重

Max loading of each basket 10KG

每个篮最大承重 10KG。

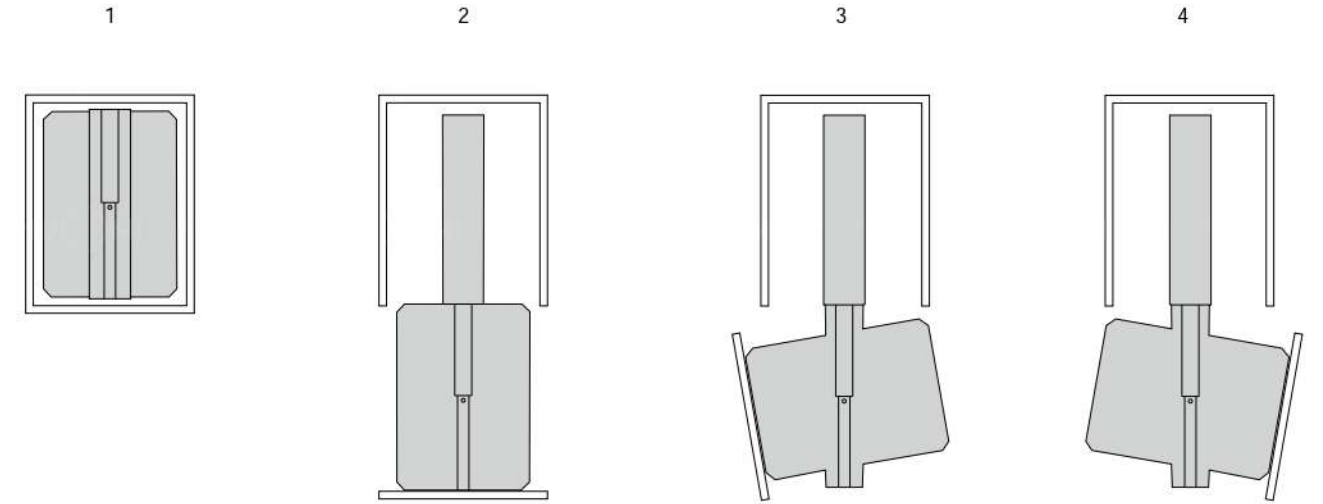

直拉式支架实现状态 / Straight Pull-out Tall Unit : 1, 2

180°旋转支架实现状态 / 180° Revolving Tall Unit : 1, 2, 3, 4.

Storage Capacity 收纳展示



The heavy damping guide rail technology is also the key to the realization of high cabinet pull-push function. Especially on the premise of a considerable weight, the heavy damping technology provides the user with excellent function guarantee during the holistic slippery pull-out, which embodies the perfect balance between the supporting capacity and the storage function.

重型阻尼导轨技术也是实现高柜拉伸功能的关键，尤其在承重量达到相当程度的前提下，整体顺滑拉出时，重型阻尼技术都为使用者提供绝佳的功能保障，体现了支撑能力与收纳功能的完美平衡。



SOFT CLOSE TALL UNIT 魅影阻尼旋转高身篮



支架型号 (直拉式) Frame item No.(Straight Pull-out)		支架型号 (180°旋转) Frame item No.(180° Revolving)		篮体型号 Basket Item No.		适用柜宽 (T) Cabinet width	规格 (长 x 宽 x 高) Width x Depth x Height	描述 Description
香槟金 Champagne gold	太郎灰 Highclass grey	香槟金 Champagne gold	太郎灰 Highclass grey	香槟金 Champagne gold	太郎灰 Highclass grey			
2010001E	2010001D	2010001C	2010001B	2010171	2010181	300mm	240x480x(1180-1480)mm	4层/Tiers
2010002E	2010002D	2010002C	2010002B	2010172	2010182	300mm	240x480x(1430-1730)mm	5层/Tiers
2010003E	2010003D	2010003C	2010003B	2010173	2010183	300mm	240x480x(1780-2080)mm	6层/Tiers
2010001E	2010001D	2010001C	2010001B	2010174	2010184	400mm	340x480x(1180-1480)mm	4层/Tiers
2010002E	2010002D	2010002C	2010002B	2010175	2010185	400mm	340x480x(1430-1730)mm	5层/Tiers
2010003E	2010003D	2010003C	2010003B	2010176	2010186	400mm	340x480x(1780-2080)mm	6层/Tiers

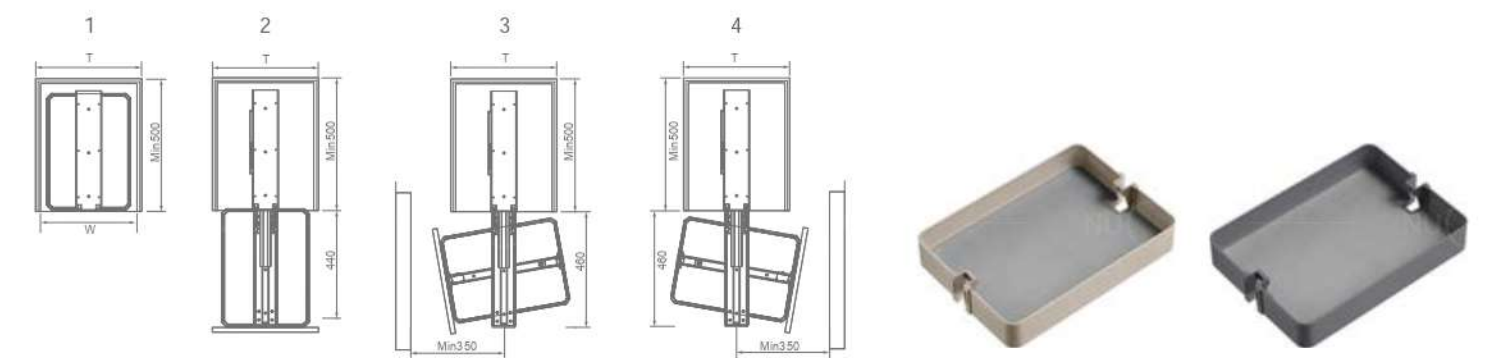

直拉式支架实现状态 /Straight Pull-out Tall Unit : 1、2
180°旋转支架实现状态 /180° Revolving Tall Unit : 1、2、3、4

BASE CABINET STORAGE

地柜系统

Reasonable planning of your space display, from top to bottom, in an orderly way, let you show your skills in an orderly space, about life, we should be more free.

合理规划您的空间陈列，自上而下，有条不紊，让您在有序空间里大展身手，关于生活，我们本该更自由一些。



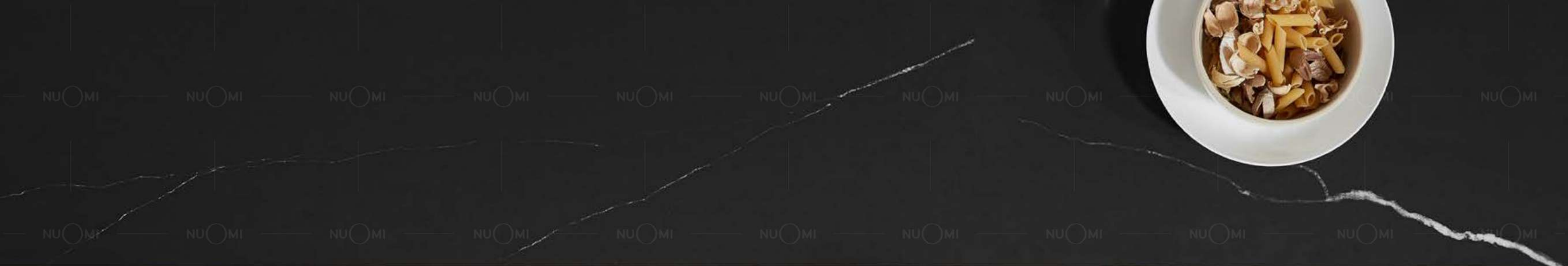



Function & Technology 功能与技术



Function 功能

Pull out basket for base cabinet, proper space partition design, satisfy the needs of storing different sizes of plates, dishes, chopsticks, spoons, slices, cups, small soup pots, making the kitchen storage neat and orderly.

橱柜基础收纳拉篮，科学合理收纳分区设置，满足各大小尺寸的碗碟、筷子汤勺、锅铲、杯子、小型汤锅等日常厨房用品存储，让厨房收纳井然有序，赏心悦目。

Quality 品质

The whole basket is made of superior aviation aluminium alloy advanced fluorocarbon surface treatment technology, strong corrosion resistance, rust resistance, abrasive resistance. The guide rail passed the European standard SGS 80000 movement test.

整个篮体选用优质航空级太空铝合金，表面采用精湛氟碳工艺，保证防腐防锈，耐磨防刮，久用如新，质感卓越；产品导轨通过欧标 SGS 80000 次运动测试。

Design 设计

Two color options, Champagne Gold and Highclass Grey. Slim sides design, interpreting minimalism and light luxury style, enhance the taste of kitchen storage. The bottom is covered by non-slip mat, prevent the items from collision, and convenient to clean at the same time. Unique structure of pullout basket, with sliding inner cutlery tray improve space utilization rate. Moveable dish rack, knife and fork box, convenient and flexible. Quick installation structure for cabinet door, easy and convenient to install.

香槟金和太师灰两种色彩选择，纤薄板式围边，完美诠释家居极简轻奢风格，使厨房收纳空间更加优雅有品位；底板防滑垫应用，防止运动过程中物品的碰撞以及噪声，同时方便清洁；通过抽中抽多层收纳结构提升立体空间利用率，同时可移动式碗碟架及刀叉盒，方便清洁卫生和灵活使用；拉篮采用快装门板设计，安装简易、方便。

Storage 储物

It is recommended to store frequently-used pot, cooker, tableware, dish, bowl, utensil and so on.

储存各类常用的锅具、炊具、餐具、碗碟、器皿等。

Loading Capacity 承重

Germany Brand HURMAR soft-close synchronous slide, smooth movement, Max loading: 30KG

德国品牌赫马阻尼缓冲同步导轨，运行平稳静谧，可最大承重 30KG。



PULL-OUT BASKET FOR COOKWARE 魅影高帮厨具篮



型号 Item No.	适用柜宽 (T) Cabinet width	宽度 x 深度 x 高度 Width x Depth x Height	材质 Material	表面处理 Surface treatment	
香槟金 Champagne gold	太郎灰 Highclass grey				
3176006	3186006	600mm	564x470x226mm	铝合金 /Aluminium	氟碳喷涂 /Fluorocarbon coating
3177006	3187006	700mm	664x470x226mm	铝合金 /Aluminium	氟碳喷涂 /Fluorocarbon coating
3177506	3187506	750mm	714x470x226mm	铝合金 /Aluminium	氟碳喷涂 /Fluorocarbon coating
3178006	3188006	800mm	764x470x226mm	铝合金 /Aluminium	氟碳喷涂 /Fluorocarbon coating
3179006	3189006	900mm	864x470x226mm	铝合金 /Aluminium	氟碳喷涂 /Fluorocarbon coating

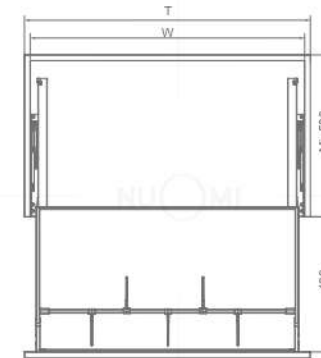



MULTIFUNCTIONAL BASKET WITH SLIDABLE CUTLERY TRAY 魅影抽中抽碗碟篮



型号 Item No.	适用柜宽 (T) Cabinet width	宽度 x 深度 x 高度 Width x Depth x Height	材质 Material	表面处理 Surface treatment	
香槟金 Champagne gold	太郎灰 Highclass grey				
3176007	3186007	600mm	564x470x226mm	铝合金 /Aluminium	氟碳喷涂 /Fluorocarbon coating
3177007	3187007	700mm	664x470x226mm	铝合金 /Aluminium	氟碳喷涂 /Fluorocarbon coating
3177507	3187507	750mm	714x470x226mm	铝合金 /Aluminium	氟碳喷涂 /Fluorocarbon coating
3178007	3188007	800mm	764x470x226mm	铝合金 /Aluminium	氟碳喷涂 /Fluorocarbon coating
3179007	3189007	900mm	864x470x226mm	铝合金 /Aluminium	氟碳喷涂 /Fluorocarbon coating





PULL-OUT BASKET WITH SLIDABLE CUTLERY TRAY 魅影抽中抽刀叉盘拉篮



型号 Item No.	适用柜宽 (T) Cabinet width	宽度 x 深度 x 高度 Width x Depth x Height	材质 Material	表面处理 Surface treatment	
香槟金 Champagne gold	太郎灰 Highclass grey				
3176008	3186008	600mm	564x470x226mm	铝合金 /Aluminium	氟碳喷涂 /Fluorocarbon coating
3177008	3187008	700mm	664x470x226mm	铝合金 /Aluminium	氟碳喷涂 /Fluorocarbon coating
3177508	3187508	750mm	714x470x226mm	铝合金 /Aluminium	氟碳喷涂 /Fluorocarbon coating
3178008	3188008	800mm	764x470x226mm	铝合金 /Aluminium	氟碳喷涂 /Fluorocarbon coating
3179008	3189008	900mm	864x470x226mm	铝合金 /Aluminium	氟碳喷涂 /Fluorocarbon coating

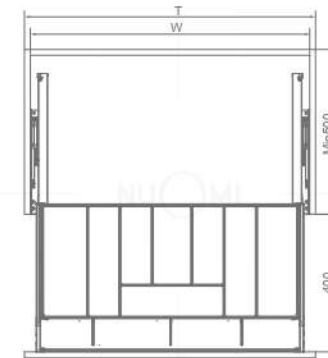



HIGH U-SHAPED BASKET UNDER SINK 魅影高帮 U 型水槽篮

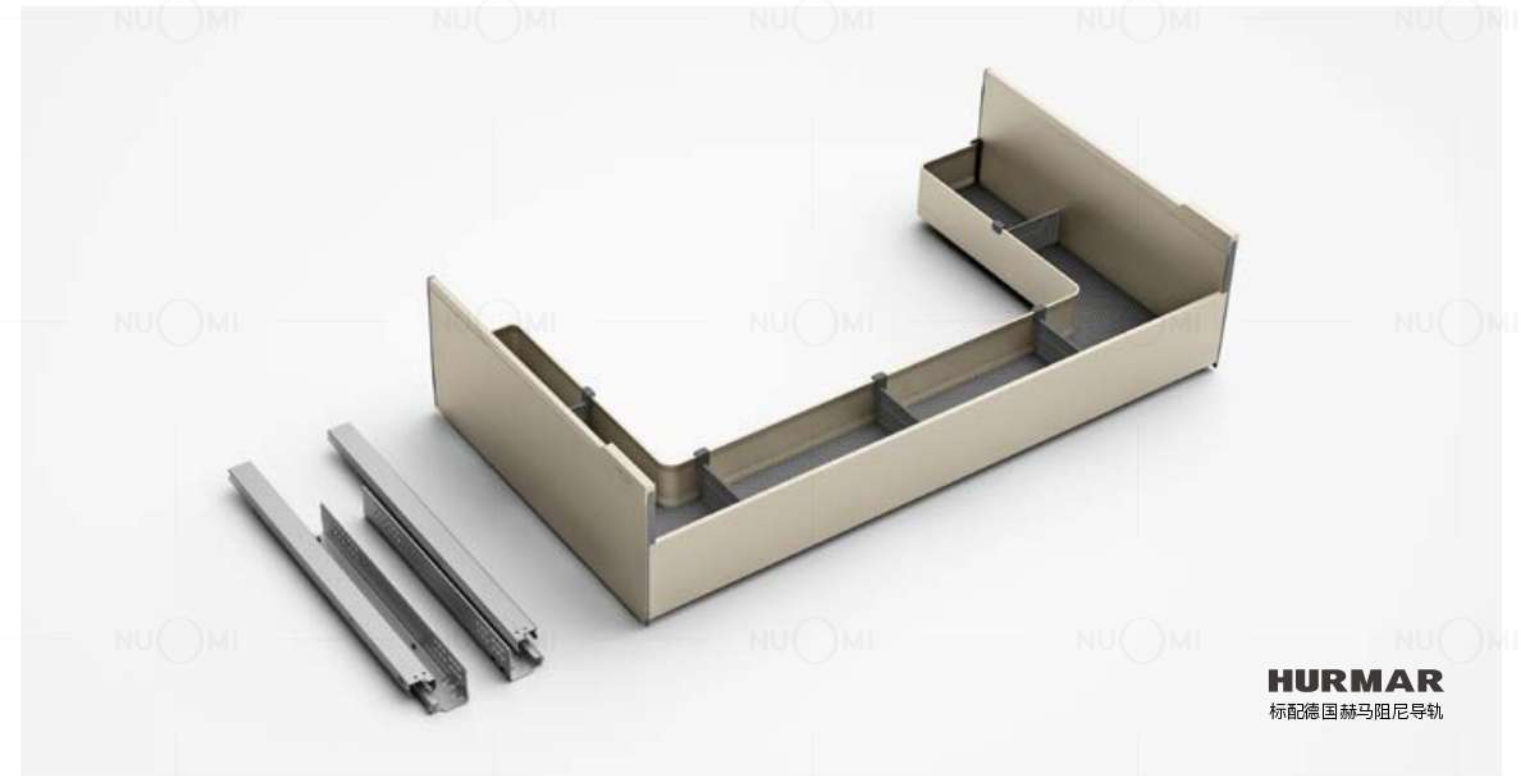

型号 Item No.	适用柜宽 (T) Cabinet width	宽度 x 深度 x 高度 Width x Depth x Height	材质 Material	表面处理 Surface treatment
香槟金 Champagne gold	太郎灰 Highclass grey			
3178009	3188009	800mm	铝合金 / Aluminium	氟碳喷涂 / Fluorocarbon coating
3179009	3189009	900mm	铝合金 / Aluminium	氟碳喷涂 / Fluorocarbon coating

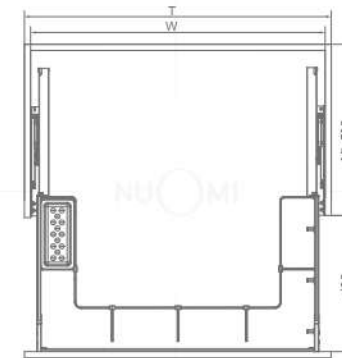



PULL-OUT BASKET 魅影常规炉头平篮



型号 Item No.	适用柜宽 (T) Cabinet width	宽度 x 深度 x 高度 Width x Depth x Height	材质 Material	表面处理 Surface treatment	
香槟金 Champagne gold	太郎灰 Highclass grey				
3176001	3186001	600mm	564x470x162mm	铝合金 /Aluminium	氟碳喷涂 /Fluorocarbon coating
3177001	3187001	700mm	664x470x162mm	铝合金 /Aluminium	氟碳喷涂 /Fluorocarbon coating
3177501	3187501	750mm	714x470x162mm	铝合金 /Aluminium	氟碳喷涂 /Fluorocarbon coating
3178001	3188001	800mm	764x470x162mm	铝合金 /Aluminium	氟碳喷涂 /Fluorocarbon coating
3179001	3189001	900mm	864x470x162mm	铝合金 /Aluminium	氟碳喷涂 /Fluorocarbon coating

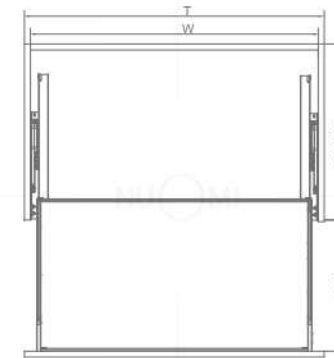



MULTIFUNCTIONAL BASKET 魅影多功能碗碟篮



型号 Item No.	适用柜宽 (T) Cabinet width	宽度 x 深度 x 高度 Width x Depth x Height	材质 Material	表面处理 Surface treatment
香槟金 Champagne gold	太郎灰 Highclass grey			
3176002	3186002	600mm	铝合金 /Aluminium	氟碳喷涂 /Fluorocarbon coating
3177002	3187002	700mm	铝合金 /Aluminium	氟碳喷涂 /Fluorocarbon coating
3177502	3187502	750mm	铝合金 /Aluminium	氟碳喷涂 /Fluorocarbon coating
3178002	3188002	800mm	铝合金 /Aluminium	氟碳喷涂 /Fluorocarbon coating
3179002	3189002	900mm	铝合金 /Aluminium	氟碳喷涂 /Fluorocarbon coating

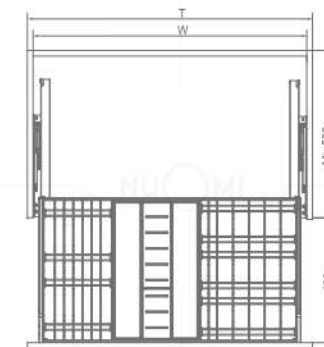



U-SHAPED BASKET UNDER SINK 魅影常规 U 型水槽篮

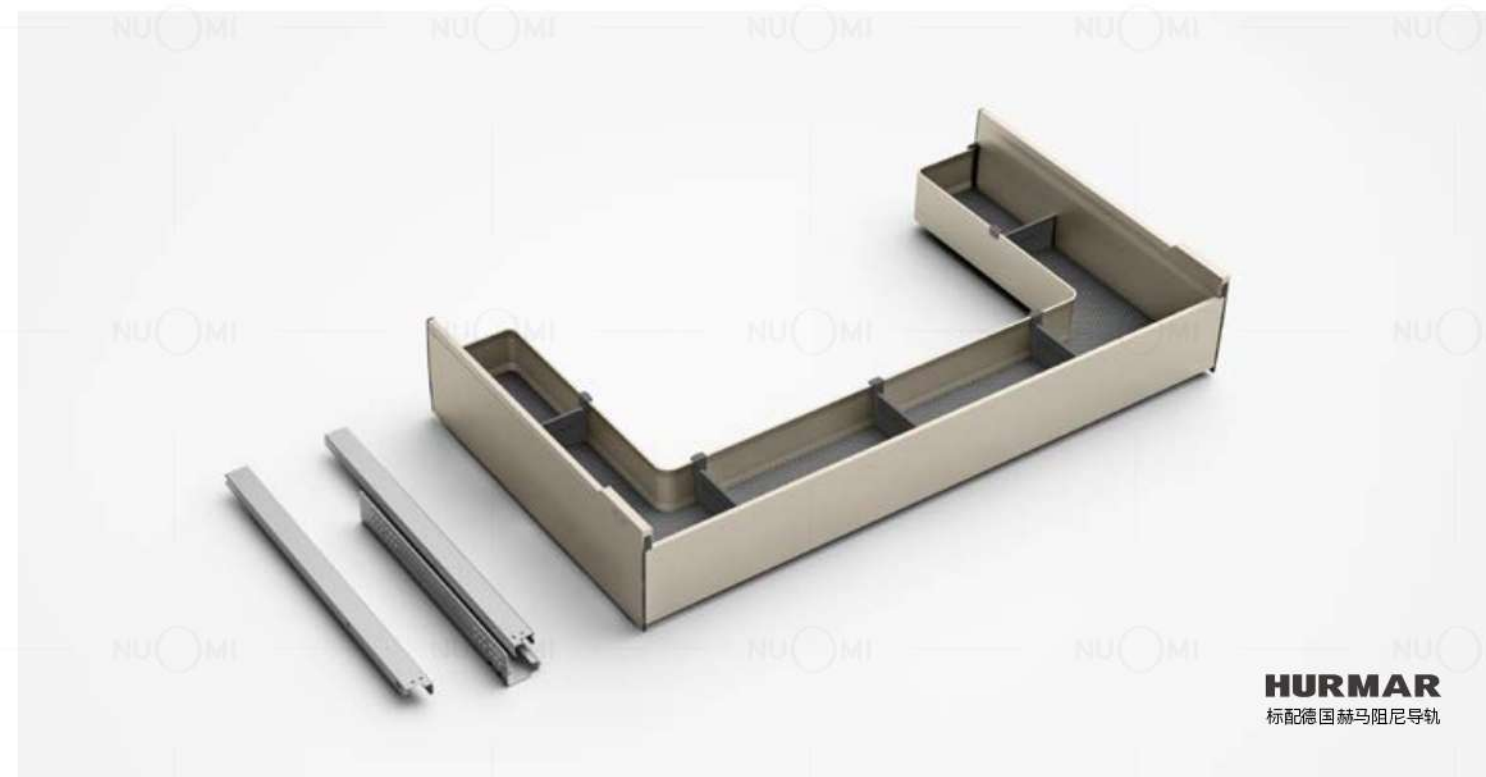

型号 Item No.	适用柜宽 (T) Cabinet width	宽度 x 深度 x 高度 Width x Depth x Height	材质 Material	表面处理 Surface treatment
香槟金 Champagne gold	太郎灰 Highclass grey			
3178005	3188005	800mm	铝合金 / Aluminium	氟碳喷涂 / Fluorocarbon coating
3179005	3189005	900mm	铝合金 / Aluminium	氟碳喷涂 / Fluorocarbon coating

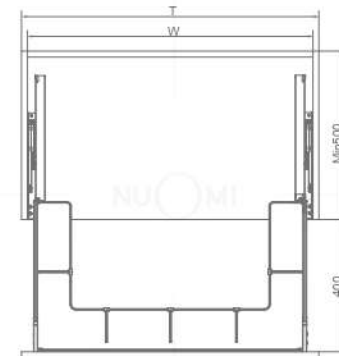

PULL-OUT BASKET WITH SLIDABLE CUTLERY TRAY

魅影抽中抽调味篮



Simplicity, comfortable home, cutting-edge technology,
exquisite craft, art and life perfectly fit.

开阔视野，畅通无阻的三面取物，极简主义，舒适家居，尖端技术，精湛工艺，将艺术与生活完美切合。

PULL-OUT BASKET WITH SLIDABLE
CUTLERY TRAY





Function & Technology 功能与技术

Function 功能

Pull out basket for base cabinet, proper space partition design, satisfy the needs of storing different sizes of cruets, condiments, oil bottles and other daily kitchen items, making the kitchen storage neat and orderly.

橱柜基础收纳拉篮，科学合理收纳分区设置，满足各大小尺寸的高矮调味瓶罐、包装调味品、大小油瓶油桶等日常厨房用品存储，让厨房收纳井井有条，赏心悦目。

Quality 品质

Sides of basket is made of superior aluminium alloy, advanced fluorocarbon coating surface treatment technology, strong, rust resistance, abrasive resistance. The guide rail passed the European standard SGS 80000 cycles movement test.

整个篮体选用优质航空级太空铝合金，表面采用精湛氟碳工艺，保证防腐防锈，耐磨防刮，久用如新，质感卓越；产品导轨通过欧标 SGS 80000 次运动测试。

Design 设计

Two color options, Champagne Gold and Highclass Grey. Slim sides design, interpreting minimalism and light luxury style, enhance the taste of kitchen storage. The bottom is covered by non-slip mat, prevent the items from collision, and convenient to clean at the same time. Unique structure of pullout basket, with sliding inner cutlery tray, improve space utilization rate. Moveable spice rack, convenient and flexible. Quick installation structure for cabinet door, easy and convenient to install.

香槟金和太师灰两种色彩选择，纤薄板式围边，完美诠释家居极简轻奢风格，使厨房收纳空间更加优雅有品位；底板防滑垫应用，防止运动过程中物品的碰撞以及噪声，同时方便清洁；通过抽中抽多层收纳结构提升立体空间利用率，同时可移动式调味瓶层架，使用时可取出放置在台面，方便烹饪操作；拉篮采用快装门板设计，安装简易、方便。

Storage 储物

It is recommended to store frequently-used cruets, condiments, oil bottles and so on.

储存各类较常用的高矮调味瓶罐、包装调味品、大小油瓶油桶等。

Loading Capacity 承重

Germany Brand HURMAR soft-close synchronous slide, smooth movement. Max loading: 30KG.

德国品牌赫马尼缓冲同步导轨，运行平稳静谧，可最大承重 30KG。

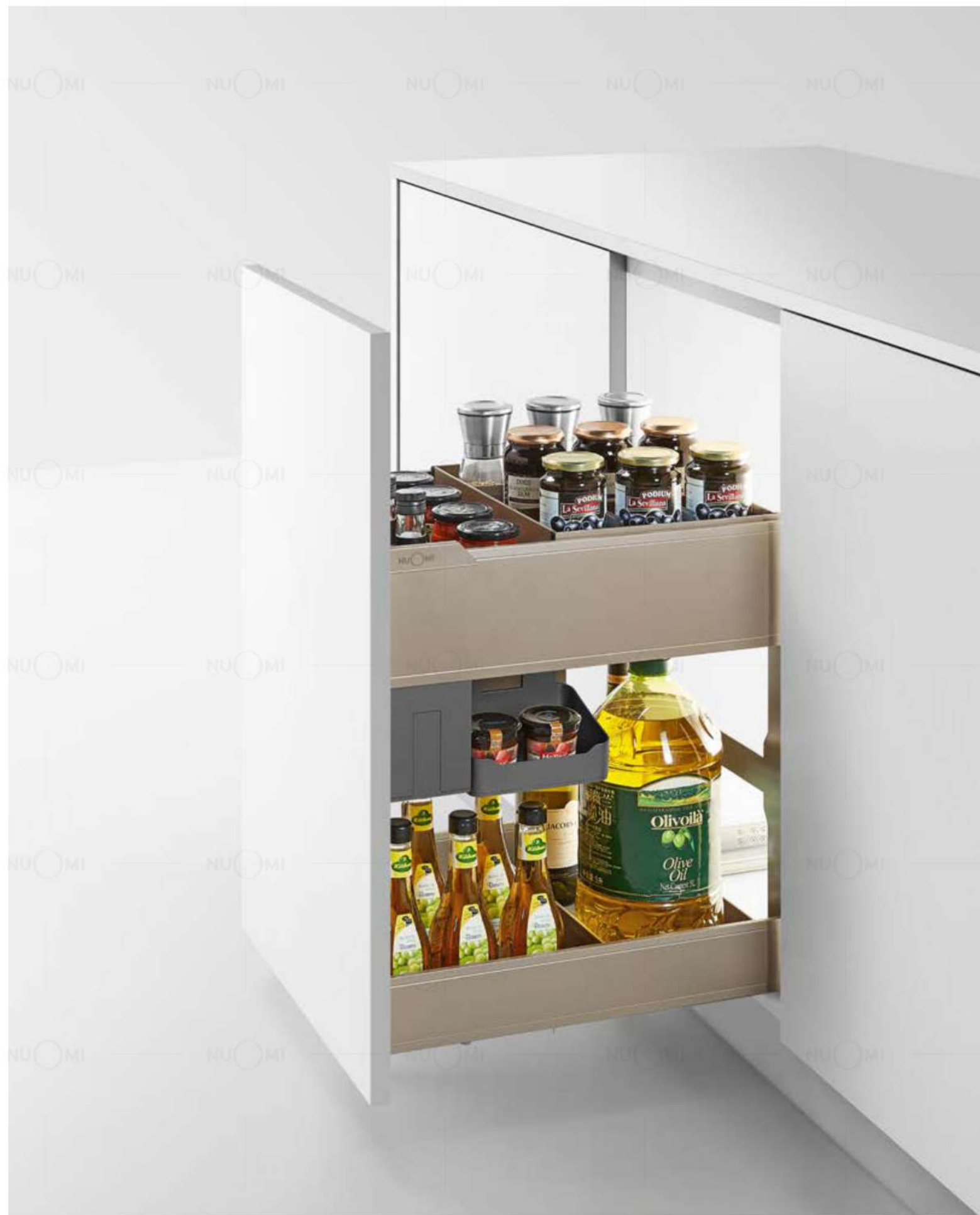

PULL-OUT BASKET WITH SLIDABLE CUTLERY TRAY 魅影抽中抽调味篮



型号 Item No.	适用柜宽 (T) Cabinet width	宽度 x 深度 x 高度 Width x Depth x Height	材质 Material	表面处理 Surface treatment
香槟金 Champagne gold	太郎灰 Highclass grey			
3174501	3184501	450mm	铝合金 /Aluminium	氟碳喷涂 /Fluorocarbon coating
3174001	3184001	400mm	铝合金 /Aluminium	氟碳喷涂 /Fluorocarbon coating

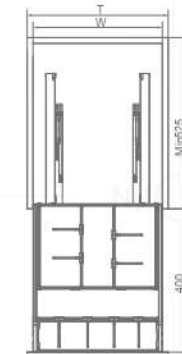



PULL-OUT BASKET WITH SLIDABLE CUTLERY TRAY 魅影抽中抽调味篮



HURMAR
标配德国赫马阻尼导轨

型号 Item No.	适用柜宽 (T) Cabinet width	宽度 x 深度 x 高度 Width x Depth x Height	材质 Material	表面处理 Surface treatment
香槟金 Champagne gold	太郎灰 Highclass grey			
3173501	3183501	350mm	铝合金 /Aluminium	氟碳喷涂 /Fluorocarbon coating
3173001	3183001	300mm	铝合金 /Aluminium	氟碳喷涂 /Fluorocarbon coating

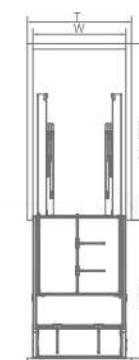



SIDE TWO-LAYERS PULL-OUT BASKET 魅影窄边篮



型号 Item No.	适用柜宽 (T) Cabinet width	宽度 x 深度 x 高度 Width x Depth x Height	材质 Material	表面处理 Surface treatment
香槟金 Champagne gold	太郎灰 Highclass grey			
3172001	3182001	200mm	铝合金 /Aluminium	氟碳喷涂 /Fluorocarbon coating
3171501	3181501	150mm	铝合金 /Aluminium	氟碳喷涂 /Fluorocarbon coating

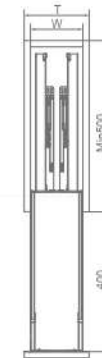



BASE CABINET MINI PANTRY ROLL-OUT 魅影地柜联动拉篮



支架型号 Frame item No.	篮体型号 Basket item No.	适用柜宽 (T) Cabinet width	规格 (长 x 宽 x 高) Width x Depth x Height	表面处理 Surface treatment		
香槟金 Champagne gold	太郎灰 Highclass grey	香槟金 Champagne gold	太郎灰 Highclass grey			
2020007C	2020007B	2020177	2020187	450mm	405x500x(600 以上 above)mm	氟碳喷涂/Fluorocarbon coating
2020008C	2020008B	2020178	2020188	600mm	555x500x(600 以上 above)mm	氟碳喷涂/Fluorocarbon coating

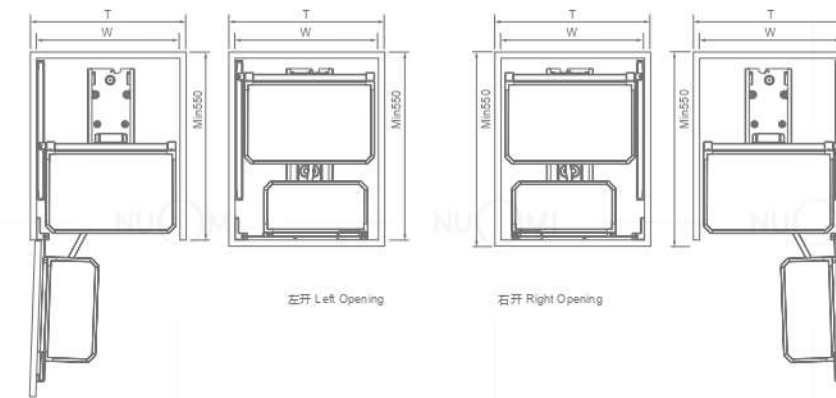



SIDE BASKET ATTACHED DOOR UNDER SINK 魅影柜门联动水槽篮



型号 Item No.	适用柜宽 (T) Cabinet width	宽度 x 深度 x 高度 Width x Depth x Height	材质 Material	表面处理 Surface treatment
香槟金 Champagne gold	太郎灰 Highclass grey			
3172006	3182006	450mm	铝合金 / Aluminium	氟碳喷涂 / Fluorocarbon coating

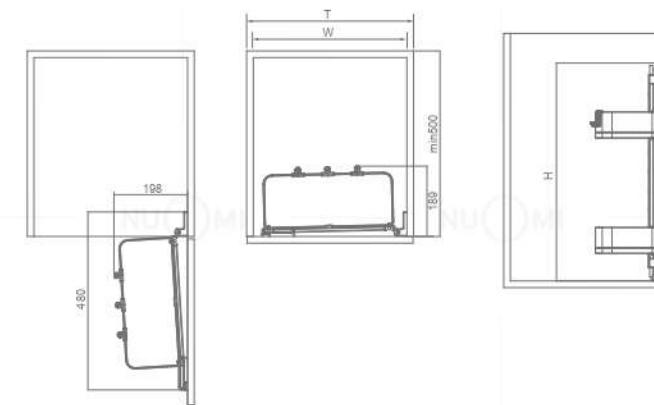

WALL CUPBOARD SYSTEM

吊柜系统



Liftable design, high space usage becomes approachable.

可升降设计，让吊柜空间利用变得平易近人。



Function 功能

Make full use of higher space of wall cupboard, more convenient to fetch high up items. Free lift, making the utilization of wall cupboard space more approachable. Humanized handle design, comfortable and convenient.

充分利用吊柜上方空间，高处存取物品更加便利；自由升降，让吊柜空间利用变得平易近人；人体工学原理掌心柄设计，给你带来舒适手感。

Quality 品质

Sides of basket is made of superior aluminium alloy, advanced fluorocarbon coating surface treatment technology, strong rust resistance, abrasive resistance. The lifter passed the European standard SGS 30000 cycles movement test.

整个篮体选用优质航空级太空铝合金，表面采用精湛氟碳工艺，保证防腐防锈，耐磨防刮，久用如新，质感卓越；升降装置在正常状态下，通过欧标SGS30000次升降测试。

Design 设计

Two color options, Champagne Gold and Highclass Grey Slim sides design, interpreting minimalism and light luxury style, enhance the taste of kitchen storage. The bottom is covered by non-slip mat, prevent the items from collision, and convenient to clean at the same time.

香槟金和太灰两种色彩选择，纤薄板式围边，完美诠释家居极简轻奢风格，使厨房收纳空间更加优雅有品位；底板防滑垫应用，防止运动过程中物品的碰撞以及噪声，同时方便清洁。

Storage 储物

It is recommended to store condiments, not commonly used tableware, non-frozen food or dried fruit and so on.

建议存放调味品、不常用的餐具、非冷冻的食物或干果等。

Loading Capacity 承重

Max loading :10KG

可最大承重 10 公斤。



SINGLE-LAYER LIFTER 魅影单层空降机



型号 Item No.	适用柜宽 (T) Cabinet width	宽度 x 深度 x 高度 Width x Depth x Height	材质 Material	表面处理 Surface treatment	
香槟金 Champagne gold	太郎灰 Highclass grey				
4176001	4186001	600mm	564x240x381.5mm	铝合金 /Aluminium	氟碳喷涂 /Fluorocarbon coating
4177001	4187001	700mm	664x240x381.5mm	铝合金 /Aluminium	氟碳喷涂 /Fluorocarbon coating
4178001	4188001	800mm	764x240x381.5mm	铝合金 /Aluminium	氟碳喷涂 /Fluorocarbon coating
4179001	4189001	900mm	864x240x381.5mm	铝合金 /Aluminium	氟碳喷涂 /Fluorocarbon coating

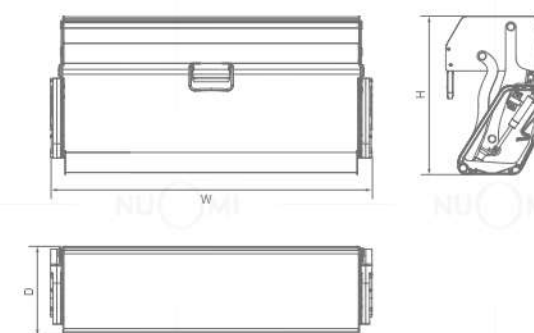

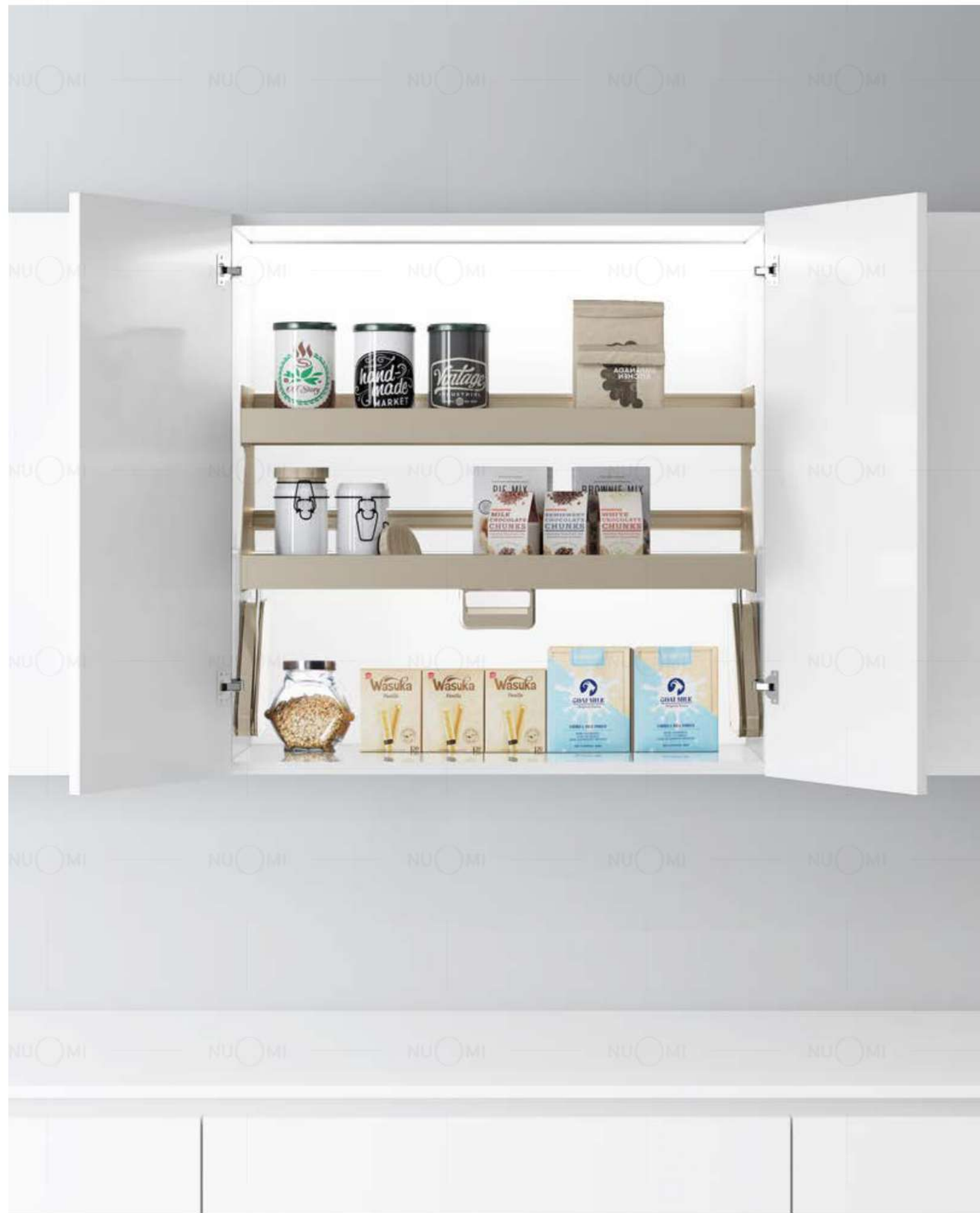

DOUBLE LAYER LIFTER 魅影双层空升降机



型号 Item No.	适用柜宽 (T) Cabinet width	宽度 x 深度 x 高度 Width x Depth x Height	材质 Material	表面处理 Surface treatment
香槟金 Champagne gold	太郎灰 Highclass grey			
4176003	4186003	600mm	铝合金 /Aluminium	氟碳喷涂 /Fluorocarbon coating
4178003	4188003	800mm	铝合金 /Aluminium	氟碳喷涂 /Fluorocarbon coating
4179003	4189003	900mm	铝合金 /Aluminium	氟碳喷涂 /Fluorocarbon coating

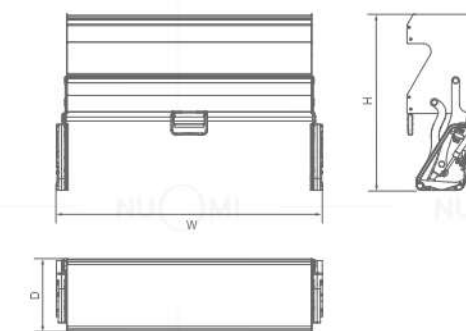

FANTASY CABIN

梦幻舱





FANTASY CABIN (PEARL WHITE / STARRY SKY BLACK) 梦幻舱 (天使白 / 星空黑)



型号 Item No.	适用柜宽 (T) Cabinet width	宽度 x 深度 x 高度 Width x Depth x Height	柜门颜色 Cupboard door color	柜体颜色 Cabinet color
4146006	600	600x350x720mm	白色玻璃 /White glass	白色 /White
4148006	800	800x350x720mm	白色玻璃 /White glass	白色 /White
4149006	900	900x350x720mm	白色玻璃 /White glass	白色 /White
4146007	600	600x350x720mm	黑色玻璃 /Black glass	白色 /White
4148007	800	800x350x720mm	黑色玻璃 /Black glass	白色 /White
4149007	900	900x350x720mm	黑色玻璃 /Black glass	白色 /White

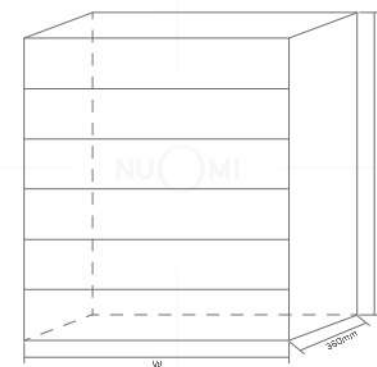

AMETHYST

紫水晶系列





Corner units Function and technology 功能与技术

Function 功能

The storage can be divided according to cooking habits. The multifunctional storage can be changed flexibly based on personal habit. Easy to store, fetch and clean, ensure health. Neat kitchen storage, clear at a glance, convenient to fetch.

根据烹饪习惯，合理划分储物空间。多个功能收纳区，可按个人习惯，灵活变动储物空间。活动碗碟架，取放自如，更易清洁、保障卫生。厨房收纳整齐、一目了然、存放方便。

Quality 品质

Basket is made of high-quality aluminium alloy and tempered glass. Slide adopts Germany technology and passed through European standard SGS80000 cycles test, much longer service life.

篮体由太空合金与钢化玻璃组合而成，超强耐腐蚀力，保证经久耐用；导轨通过欧标 SGS80000 次运动测试。

Design 设计

Standard with German soft-close slide, works smoothly and steady, silent and auto-close; Easily mounted with cabinet door, convenient for installation; Bottom adopts double layer structure of stainless steel panel and 5mm PVC board, which is national patent design, strengthens the load-bearing.

标配德国阻尼导轨，开合顺滑流畅，静音自动复位；拉篮采用快装门板设计，安装简易、方便；底板采用专利带支撑板双层结构，不锈钢板结合 5mm 厚的 PVC 底板，承载力加强。

Storage 储物

It is recommended to store different kinds of kitchenware, cooker, tableware, condiment according to different storage space.

建议根据不同区域储存各类厨房器皿、炊具、餐具、调味品等。

Loading Capacity 承重

Germany Brand HURMAR soft-close synchronous slide, Max loading: 30KG

德国品牌赫马阻尼缓冲同步导轨，可最大承重 30KG。



CORNER UNITS

转角系统

Magic corner, make the best use of corner space of Cabinet width, easily pullout the inner items from corner.

转角小怪物，充分利用厨房转角空间，实现所有物品拉出柜体，即使面对最里面的物件，也可轻松存取。





SOFT-CLOSE MAGIC CORNER 紫水晶小怪物



支架型号 Frame item No.	篮体型号 Basket item No.	适用柜宽 (T) Cabinet width	规格 (长 x 宽 x 高) Width x Depth x Height	描述 Description
1010001B	1010070A	900-1000mm	(860-960)x530x520mm	左开 /Left open
1010002B	1010070A	900-1000mm	(860-960)x530x520mm	右开 /Right open

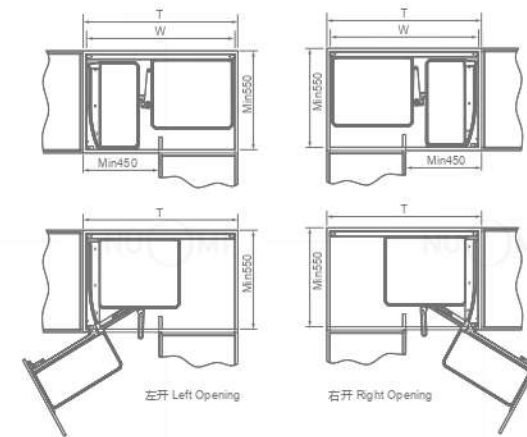

TALL CABINET SYSTEM

高柜系统

Unique linkage design, open the door at the same time with all the baskets, convenient storage. Mute design, so that the product in the process of opening and closing, always maintain smooth effect. Double guide rail design, different from the previous single guide rail mode, strengthen the bearing capacity of the product, and make the pull out maintain stable.

独特的联动设计，在开门的同时带出全部篮子，方便存放物品。静音设计，使产品在开合过程中，始终保持平稳、顺畅的效果。双导轨设计，一改以往单导轨模式，强化产品的承载能力，并使拉出保持平稳。





AMETHYST 紫水晶航母台



支架型号 Frame item No.	篮体型号 Basket item No.	适用柜宽 (T) Cabinet width	规格 (长 x 宽 x 高) Width x Depth x Height	描述 Description
2030001B	2030071A	450mm	(404-424)x500x1430mm	4层 /Tiers
2030001B	2030073A	600mm	(554-574)x500x1430mm	4层 /Tiers
2030002B	2030072A	450mm	(404-424)x500x1780mm	5层 /Tiers
2030002B	2030074A	600mm	(554-574)x500x1780mm	5层 /Tiers

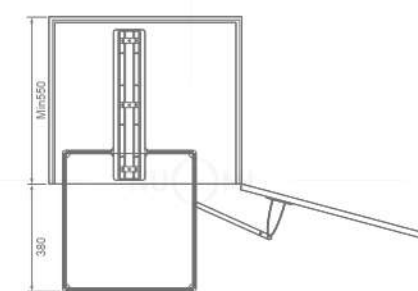
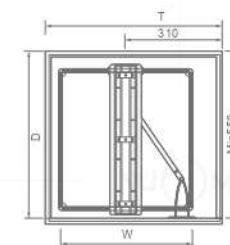

建议门板使用 165° 铰链
Suggesting cabinet door being mounted with 165° hinge



PANTRY ROLL-OUT 紫水晶大怪物



支架型号 Frame item No.	篮体型号 Basket item No.	适用柜宽 (T) Cabinet width	规格 (长 x 宽 x 高) Width x Depth x Height	描述 Description
2020001B	2020071A	450mm	405x500x(1180 以上 above)mm	4层 /Tiers
2020002B	2020072A	450mm	405x500x(1430 以上 above)mm	5层 /Tiers
2020003B	2020073A	450mm	405x500x(1780 以上 above)mm	6层 /Tiers
2020004B	2020074A	600mm	555x500x(1180 以上 above)mm	4层 /Tiers
2020005B	2020075A	600mm	555x500x(1430 以上 above)mm	5层 /Tiers
2020006B	2020076A	600mm	555x500x(1780 以上 above)mm	6层 /Tiers

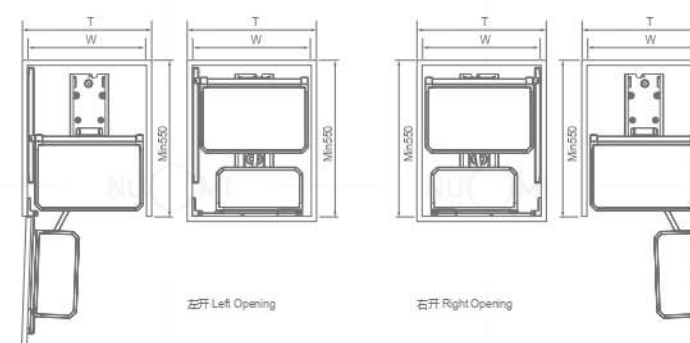



REVOLVING TALL UNIT 紫水晶阻尼旋转高身篮



支架型号 (直拉式) Frame item No.(Straight Pull-out)	支架型号 (180°旋转) Frame item No.(180° Revolving)	篮体型号 Basket item No.	适用柜宽 (T) Cabinet width	规格 (长 x 宽 x 高) Width x Depth x Height	描述 Description
2010001D	2010001B	2010071A	300mm	240x480x(1180-1480)mm	4层 /Tiers
2010002D	2010002B	2010072A	300mm	240x480x(1430-1730)mm	5层 /Tiers
2010003D	2010003B	2010073A	300mm	240x480x(1780-2080)mm	6层 /Tiers
2010001D	2010001B	2010074A	400mm	340x480x(1180-1480)mm	4层 /Tiers
2010002D	2010002B	2010075A	400mm	340x480x(1430-1730)mm	5层 /Tiers
2010003D	2010003B	2010076A	400mm	340x480x(1780-2080)mm	6层 /Tiers

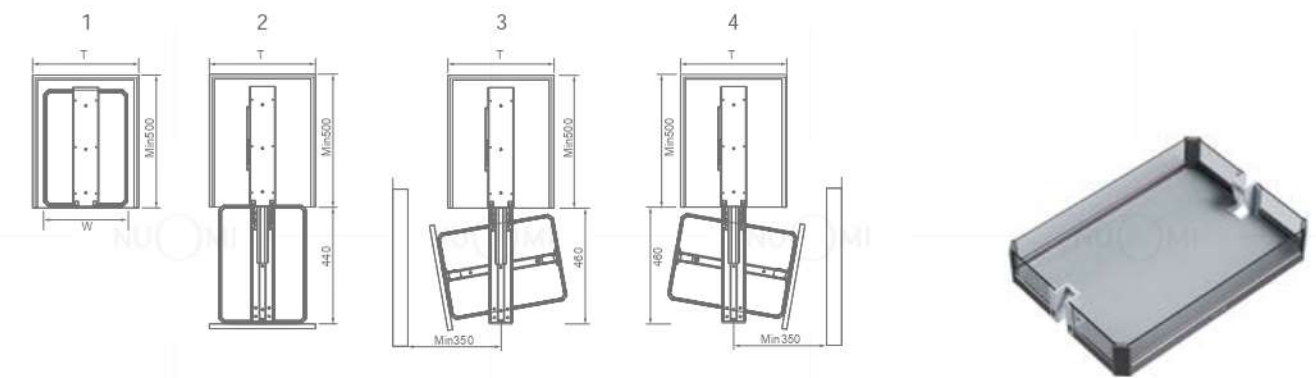

直拉式支架实现状态 /Straight Pull-out Tall Unit : 1、2
180°旋转支架实现状态 /180° Revolving Tall Unit : 1、2、3、4

BASE CABINET SYSTEM

地柜系统



To be simple and to see the simple sides of life; the beauty and storage functions are all important, so that the dream kitchen can be closer to your life.

去繁就简，窥见生活的简练一面，美观、储物功能一样不少，让梦想厨房更贴近您的生活。





PULL-OUT BASKET 紫水晶三边平篮



HURMAR
标配德国赫马阻尼导轨

型号 Item No.	适用柜宽 (T) Cabinet width	宽度 x 深度 x 高度 Width x Depth x Height	材质 Material	表面 Surface	工艺 Process
3076001	600mm	564x450x170mm	太空合金 + 玻璃 / Aluminium + glass	电镀紫 / Polish purple	机抛三酸 / Mechanical polish over acid
3077001	700mm	664x450x170mm	太空合金 + 玻璃 / Aluminium + glass	电镀紫 / Polish purple	机抛三酸 / Mechanical polish over acid
3077501	750mm	714x450x170mm	太空合金 + 玻璃 / Aluminium + glass	电镀紫 / Polish purple	机抛三酸 / Mechanical polish over acid
3078001	800mm	764x450x170mm	太空合金 + 玻璃 / Aluminium + glass	电镀紫 / Polish purple	机抛三酸 / Mechanical polish over acid
3079001	900mm	864x450x170mm	太空合金 + 玻璃 / Aluminium + glass	电镀紫 / Polish purple	机抛三酸 / Mechanical polish over acid

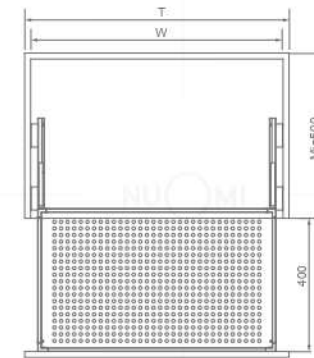



MULTIFUNCTIONAL PULL-OUT BASKET 紫水晶三边碗碟篮



型号 Item No.	适用柜宽 (T) Cabinet width	宽度 x 深度 x 高度 Width x Depth x Height	材质 Material	表面 Surface	工艺 Process
3076002	600mm	564x450x170mm	太空合金 + 玻璃 / Aluminium + glass	电镀紫 / Polish purple	机抛三酸 / Mechanical polish over acid
3077002	700mm	664x450x170mm	太空合金 + 玻璃 / Aluminium + glass	电镀紫 / Polish purple	机抛三酸 / Mechanical polish over acid
3077502	750mm	714x450x170mm	太空合金 + 玻璃 / Aluminium + glass	电镀紫 / Polish purple	机抛三酸 / Mechanical polish over acid
3078002	800mm	764x450x170mm	太空合金 + 玻璃 / Aluminium + glass	电镀紫 / Polish purple	机抛三酸 / Mechanical polish over acid
3079002	900mm	864x450x170mm	太空合金 + 玻璃 / Aluminium + glass	电镀紫 / Polish purple	机抛三酸 / Mechanical polish over acid

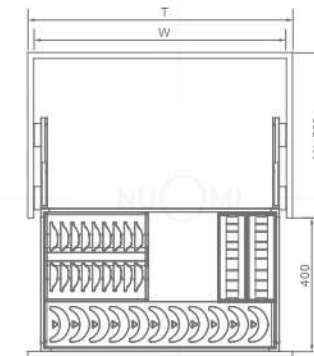



FRONT PANEL WITH HANDLE FOR PULL-OUT BASKET 紫水晶四边面板配件



型号 Item No.	适用柜宽 (T) Cabinet width	宽度 x 深度 x 高度 Width x Depth x Height	材质 Material	表面 Surface	工艺 Process
3076000	600mm	505x16x115mm	太空合金 + 玻璃 / Aluminium + glass	电镀紫 / Polish purple	机抛三酸 / Mechanical polish over acid
3077000	700mm	605x16x115mm	太空合金 + 玻璃 / Aluminium + glass	电镀紫 / Polish purple	机抛三酸 / Mechanical polish over acid
3077500	750mm	655x16x115mm	太空合金 + 玻璃 / Aluminium + glass	电镀紫 / Polish purple	机抛三酸 / Mechanical polish over acid
3078000	800mm	705x16x115mm	太空合金 + 玻璃 / Aluminium + glass	电镀紫 / Polish purple	机抛三酸 / Mechanical polish over acid
3079000	900mm	805x16x115mm	太空合金 + 玻璃 / Aluminium + glass	电镀紫 / Polish purple	机抛三酸 / Mechanical polish over acid



PULL-OUT BASKET FOR SEASONING

调味篮



Designed for modern fashion kitchen, small space, large function, planning your space storage, top-down, orderly, open a new high quality of life.

专为现代时尚厨房设计，小空间，大功能，规划您的空间储存，自上而下，有条不紊，开启全新高品质生活。



Kitchen
Functional
Hardware





PULL-OUT BASKET FOR SEASONING 紫水晶调味篮

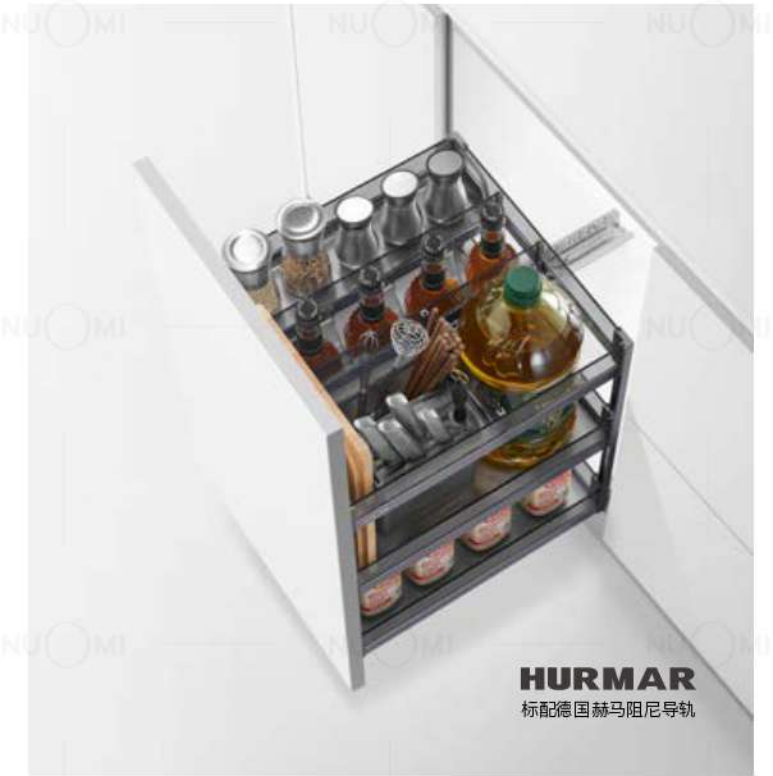

型号 Item No.	适用柜宽 (T) Cabinet width	宽度 x 深度 x 高度 Width x Depth x Height	材质 Material	表面 Surface	工艺 Process
3074501	450mm	400x450x490mm	太空合金 + 玻璃 / Aluminium + glass	电镀紫 / Polish purple	机抛三酸 / Mechanical polish over acid



PULL-OUT BASKET FOR SEASONING 紫水晶调味篮

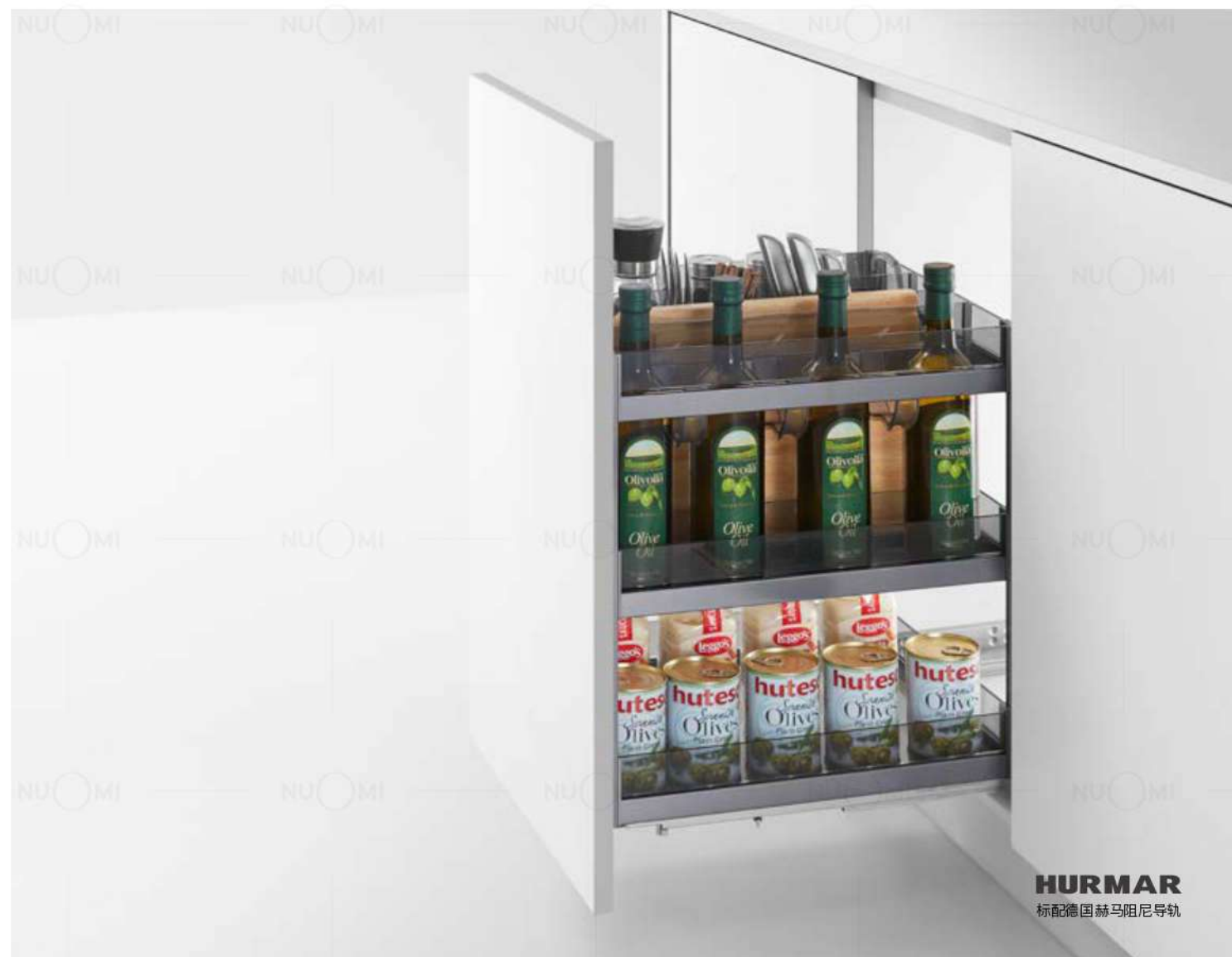

型号 Item No.	适用柜宽 (T) Cabinet width	宽度 x 深度 x 高度 Width x Depth x Height	材质 Material	表面 Surface	工艺 Process
3074001	400mm	350x450x490mm	太空合金 + 玻璃 / Aluminium + glass	电镀紫 / Polish purple	机抛三酸 / Mechanical polish over acid

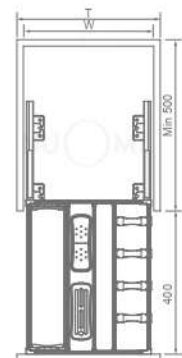

PULL-OUT BASKET FOR SEASONING 紫水晶调味篮



型号 Item No.	适用柜宽 (T) Cabinet width	宽度 x 深度 x 高度 Width x Depth x Height	材质 Material	表面 Surface	工艺 Process
3074002	400mm	350x450x490mm	太空合金 + 玻璃 / Aluminium + glass	电镀紫 / Polish purple	机抛三酸 / Mechanical polish over acid



PULL-OUT BASKET FOR SEASONING 紫水晶调味篮



型号 Item No.	适用柜宽 (T) Cabinet width	宽度 x 深度 x 高度 Width x Depth x Height	材质 Material	表面 Surface	工艺 Process
3073501	350mm	300x450x490mm	太空合金 + 玻璃 / Aluminium + glass	电破紫 / Polish purple	机抛三酸 / Mechanical polish over acid

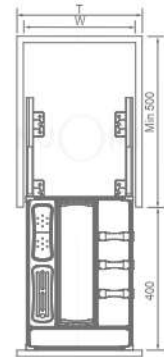

PULL-OUT BASKET FOR SEASONING 紫水晶调味篮



型号 Item No.	适用柜宽 (T) Cabinet width	宽度 x 深度 x 高度 Width x Depth x Height	材质 Material	表面 Surface	工艺 Process
3073001	300mm	250x450x490mm	太空合金 + 玻璃 / Aluminium + glass	电破紫 / Polish purple	机抛三酸 / Mechanical polish over acid

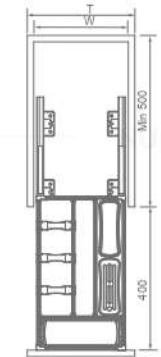

PULL-OUT BASKET FOR SEASONING 紫水晶窄边篮



型号 Item No.	适用柜宽 (T) Cabinet width	宽度 x 深度 x 高度 Width x Depth x Height	材质 Material	表面 Surface	工艺 Process
3072001	200mm	150x450x490mm	太空合金 + 玻璃 / Aluminium + glass	电镀紫 / Polish purple	机抛三酸 / Mechanical polish over acid

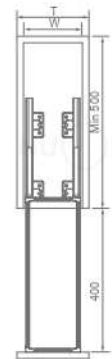

SIDE-AMOUNTED BASKET UNDER SINK 紫水晶侧装水槽篮



型号 Item No.	适用柜宽 (T) Cabinet width	宽度 x 深度 x 高度 Width x Depth x Height	材质 Material	表面 Surface	工艺 Process
3072004A	--	215x460x450mm	太空合金 + 玻璃 / Aluminium + glass	电镀紫 / Polish purple	机抛三酸 / Mechanical polish over acid

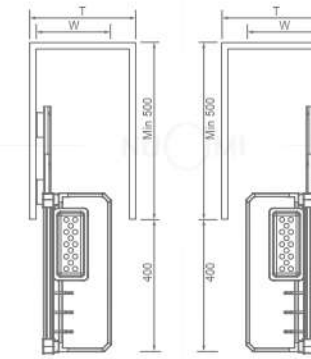

左开 Left Opening 右开 Right Opening





BASE CABINET PANTRY ROLL-OUT 紫水晶地柜联动篮



支架型号 Frame item No.	篮体型号 Basket item No.	适用柜宽 (T) Cabinet width	规格 (长 x 宽 x 高) Width x Depth x Height	描述 Description
2020007B	2020077A	450mm	405x500x(600 以上 above)mm	左右共用 /Universal for left & right
2020008B	2020078A	600mm	555x500x(600 以上 above)mm	左右共用 /Universal for left & right

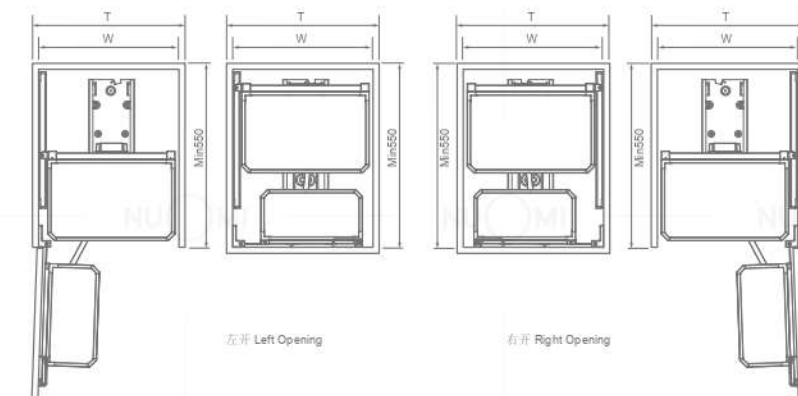

WALL CUPBOARD SYSTEM

吊柜系统

Liftable design, make the best use of higher space.
Humanized design, adjust pull and resilience force
according to loading weight, make the usage more safe and
comfortable.

可升降设计，让吊柜空间利用变得平易近人。人性化设计，可根
据储物重量调节下拉力和或弹力，让上下取物更安全。





SOFT-CLOSE LIFTING UNIT 紫水晶双层空升降机



型号 Item No.	适用柜宽 (T) Cabinet width	宽度 x 深度 x 高度 Width x Depth x Height	材质 Material	表面 Surface	工艺 Process
4076001A	600mm	564x275x550mm	太空合金 + 玻璃 / Aluminium + glass	电镀紫 / Polish purple	机抛三酸 / Mechanical polish over acid
4077001A	700mm	664x275x550mm	太空合金 + 玻璃 / Aluminium + glass	电镀紫 / Polish purple	机抛三酸 / Mechanical polish over acid
4078001A	800mm	764x275x550mm	太空合金 + 玻璃 / Aluminium + glass	电镀紫 / Polish purple	机抛三酸 / Mechanical polish over acid
4079001A	900mm	864x275x550mm	太空合金 + 玻璃 / Aluminium + glass	电镀紫 / Polish purple	机抛三酸 / Mechanical polish over acid

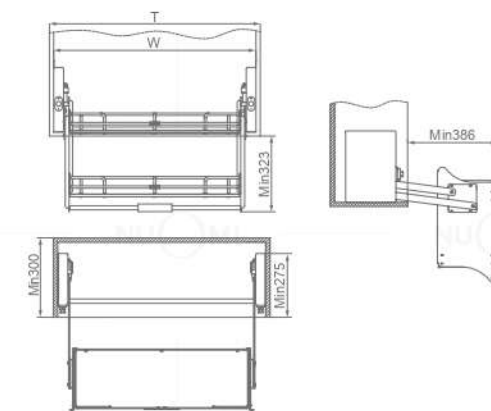

TERRAS

特拉斯系列





Corner units Function and technology 功能与技术

Function 功能

The storage can be divided according to cooking habits. The multifunctional storage can be changed flexibly based on personal habit. Easy to store, fetch and clean, ensure health. Neat kitchen storage, clear at a glance, convenient to fetch.

根据烹饪习惯，合理划分储物空间。多个功能收纳区，可按个人习惯，灵活变动储物空间。活动碗碟架，取放自如，更易清洁、保障卫生。厨房收纳整齐、一目了然、存放方便。

Quality 品质

Basket is made of good quality stainless steel, which is pioneering wire drawing technology for the surface treatment, excellent texture, strongest corrosion resistant ability. Slide passes through European standard SGS80000 cycles test.

整个篮体优选优质不锈钢，表面经德国先进拉丝技术处理，质感卓越，抗锈能力强；导轨通过欧标SGS80000次运动测试。

Design 设计

Standard with NUOMI soft-close slide, works smoothly and steady, silent and auto-close; Easily mounted with cabinet door, convenient for installation; Bottom adopts double layer structure of stainless steel panel and 5mm PVC board, which is national patent design, strengthens the load-bearing.

标配诺米阻尼导轨，开合顺滑流畅，静音自动复位；拉篮采用快装门板设计，安装简易、方便；底板采用专利带支撑板双层结构，不锈钢板结合5mm厚的PVC底板，承重能力加强。

Storage 储物

It is recommended to store different kinds of kitchenware, cooker, tableware, condiment according to different storage space.

建议根据不同区域储存各类厨房器皿、炊具、餐具、调味品等。

Loading Capacity 承重

NUOMI soft-close slide, Max loading: 30KG

诺米阻尼导轨，可最大承重30KG。



CORNER UNITS

转角系统

Make full use of kitchen corner space, conveniently pull out inner articles.

转角小怪物，充分利用厨房转角空间，实现所有物品拉出柜体，即使最里面的物件，也可轻松存取。





SOFT-CLOSE MAGIC CORNER 特拉斯小怪物



支架型号 Frame item No.	篮体型号 Basket item No.	适用柜宽 (T) Cabinet width	规格 (长 x 宽 x 高) Width x Depth x Height	描述 Description
1010001B	1010010	900-1000mm	(860-960)x530x520mm	左开 /Left open
1010002B	1010010	900-1000mm	(860-960)x530x520mm	右开 /Right open

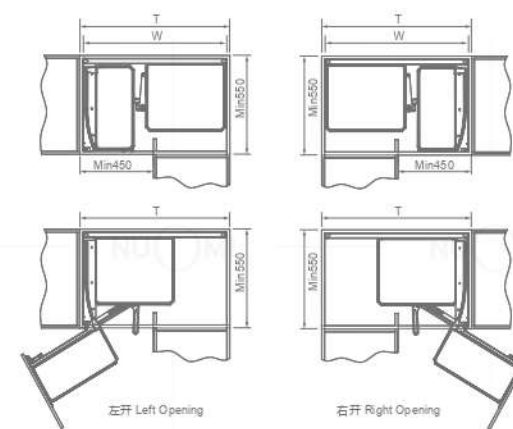

TALL CABINET SYSTEM

高柜系统

The simplest luxurious product pursues the refined and concise design. Return to the true meaning of life, feel the warm experience and perfect enjoyment brought by the extreme pursuit, and experiencing the highest comfortable state of life.

极简奢华臻品，追求精炼简洁设计。回归生活本真，用心感受极致追求带来的温馨体验和完美享受，体验生活最高舒适状态。





PANTRY ROLL-OUT 特拉斯大怪物



支架型号 Frame item No.	篮体型号 Basket item No.	适用柜宽 (T) Cabinet width	规格 (长 x 宽 x 高) Width x Depth x Height	描述 Description
2020001B	2020011	450mm	405x500x(1180 以上 above)mm	4层 /Tiers
2020002B	2020012	450mm	405x500x(1430 以上 above)mm	5层 /Tiers
2020003B	2020013	450mm	405x500x(1780 以上 above)mm	6层 /Tiers
2020004B	2020014	600mm	555x500x(1180 以上 above)mm	4层 /Tiers
2020005B	2020015	600mm	555x500x(1430 以上 above)mm	5层 /Tiers
2020006B	2020016	600mm	555x500x(1780 以上 above)mm	6层 /Tiers

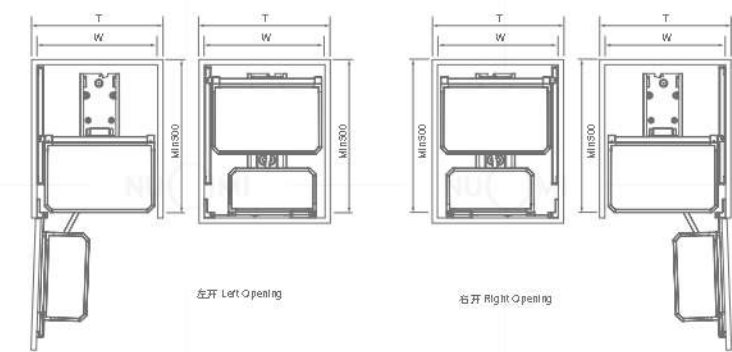



REVOLVING TALL UNIT 特拉斯阻尼旋转高身篮



支架型号 (直拉式) Frame item No.(Straight Pull-out)	支架型号 (180°旋转) Frame item No.(180° Revolving)	篮体型号 Basket item No.	适用柜宽 (T) Cabinet width	规格 (长 x 宽 x 高) Width x Depth x Height	描述 Description
2010001D	2010001B	2010011	300mm	240x480x(1180-1480)mm	4层 /Tiers
2010002D	2010002B	2010012	300mm	240x480x(1430-1730)mm	5层 /Tiers
2010003D	2010003B	2010013	300mm	240x480x(1780-2080)mm	6层 /Tiers
2010001D	2010001B	2010014	400mm	340x480x(1180-1480)mm	4层 /Tiers
2010002D	2010002B	2010015	400mm	340x480x(1430-1730)mm	5层 /Tiers
2010003D	2010003B	2010016	400mm	340x480x(1780-2080)mm	6层 /Tiers

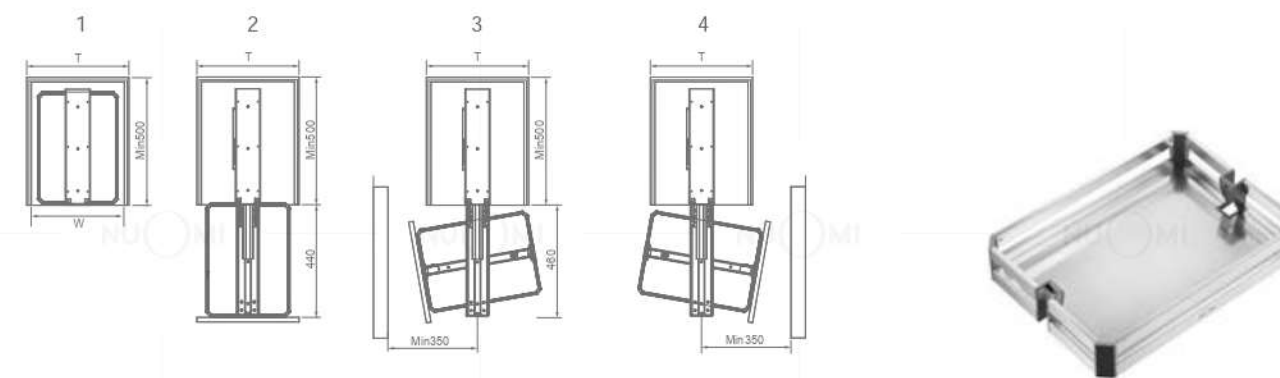

直拉式支架实现状态 /Straight Pull-out Tall Unit : 1、2
180°旋转支架实现状态 /180° Revolving Tall Unit : 1、2、3、4

BASE CABINET SYSTEM

地柜系统

The combination of elegance and practicality seeks a balance between function and aesthetics. The elegant, chic and concise modelling embodies an angular attitude of life, high-quality products and intimate design can have comfortable enjoyment.

高雅与实用的结合，在功能和美学之间寻求一种平衡，精巧别致的简洁造型体现了有棱有角的生活态度，优质的产品，贴心的设计，舒适尽享。





PULL-OUT BASKET 特拉斯三边平篮



型号 Item No.	适用柜宽 (T) Cabinet width	宽度 x 深度 x 高度 Width x Depth x Height	材质 Material	表面 Surface	工艺 Process
3016001	600mm	564x450x170mm	不锈钢 / SUS201	拉丝 / Wire drawing	拉丝 / Wire drawing
3017001	700mm	664x450x170mm	不锈钢 / SUS201	拉丝 / Wire drawing	拉丝 / Wire drawing
3017201	720mm	684x450x170mm	不锈钢 / SUS201	拉丝 / Wire drawing	拉丝 / Wire drawing
3017501	750mm	714x450x170mm	不锈钢 / SUS201	拉丝 / Wire drawing	拉丝 / Wire drawing
3018001	800mm	764x450x170mm	不锈钢 / SUS201	拉丝 / Wire drawing	拉丝 / Wire drawing
3019001	900mm	864x450x170mm	不锈钢 / SUS201	拉丝 / Wire drawing	拉丝 / Wire drawing

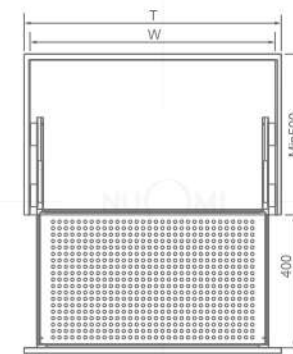



MULTIFUNCTIONAL PULL-OUT BASKET 特拉斯三边碗碟篮



型号 Item No.	适用柜宽 (T) Cabinet width	宽度 x 深度 x 高度 Width x Depth x Height	材质 Material	表面 Surface	工艺 Process
3016002	600mm	564x450x170mm	不锈钢/SUS201	拉丝/Wire drawing	拉丝/Wire drawing
3017002	700mm	664x450x170mm	不锈钢/SUS201	拉丝/Wire drawing	拉丝/Wire drawing
3017202	720mm	684x450x170mm	不锈钢/SUS201	拉丝/Wire drawing	拉丝/Wire drawing
3017502	750mm	714x450x170mm	不锈钢/SUS201	拉丝/Wire drawing	拉丝/Wire drawing
3018002	800mm	764x450x170mm	不锈钢/SUS201	拉丝/Wire drawing	拉丝/Wire drawing
3019002	900mm	864x450x170mm	不锈钢/SUS201	拉丝/Wire drawing	拉丝/Wire drawing

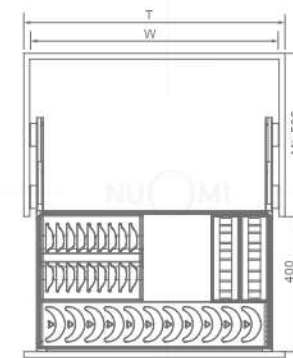



QUADRANGLE PANEL FITTINGS 特拉斯四边面板配件

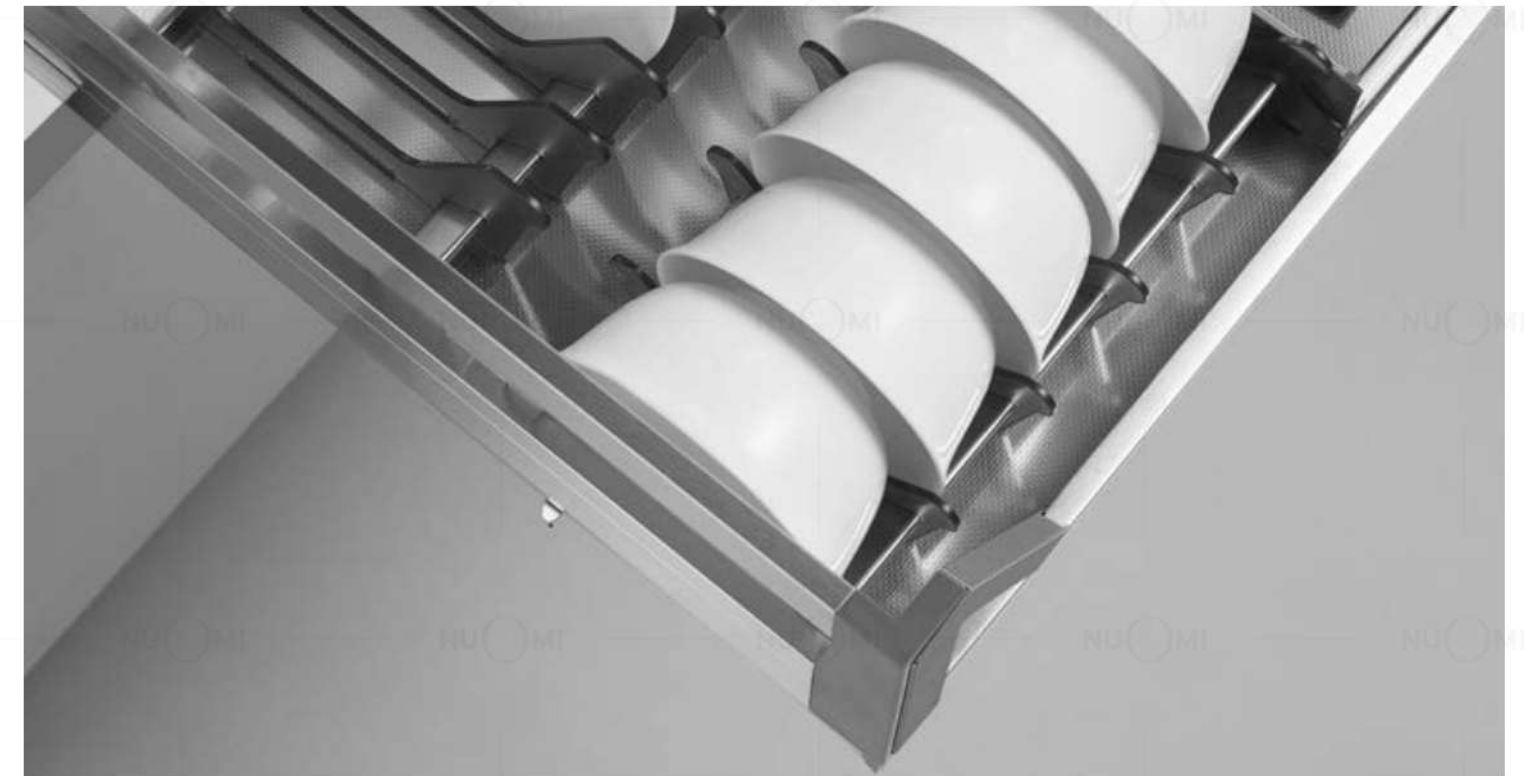

型号 Item No.	适用柜宽 (T) Cabinet width	宽度 x 深度 x 高度 Width x Depth x Height	材质 Material	表面 Surface	工艺 Process
3016000	600mm	505x16x115mm	不锈钢 /SUS201	拉丝 /Wire drawing	拉丝 /Wire drawing
3017000	700mm	605x16x115mm	不锈钢 /SUS201	拉丝 /Wire drawing	拉丝 /Wire drawing
3017500	750mm	655x16x115mm	不锈钢 /SUS201	拉丝 /Wire drawing	拉丝 /Wire drawing
3018000	800mm	705x16x115mm	不锈钢 /SUS201	拉丝 /Wire drawing	拉丝 /Wire drawing
3019000	900mm	805x16x115mm	不锈钢 /SUS201	拉丝 /Wire drawing	拉丝 /Wire drawing



PULL-OUT BASKET FOR SEASONING

调味篮



Rich functions make kitchen life more elegant. Clean and efficient storage function, let you know all the items at a glance, easy and efficient meal preparation. Experience the highest comfort of life.

丰富的功能让厨房生活更优雅。整洁高效的收纳功能，让您对所有物品一目了然，轻松高效地备餐。体验生活的最高舒适状态。



SMOOTH MOVEMENT

Kitchen
Functional
Hardware





PULL-OUT BASKET FOR SEASONING 特拉斯调味篮



型号 Item No.	适用柜宽 (T) Cabinet width	宽度 x 深度 x 高度 Width x Depth x Height	材质 Material	表面 Surface	工艺 Process
3014501	450mm	400x450x490mm	不锈钢 /SUS201	拉丝 /Wire drawing	拉丝 /Wire drawing

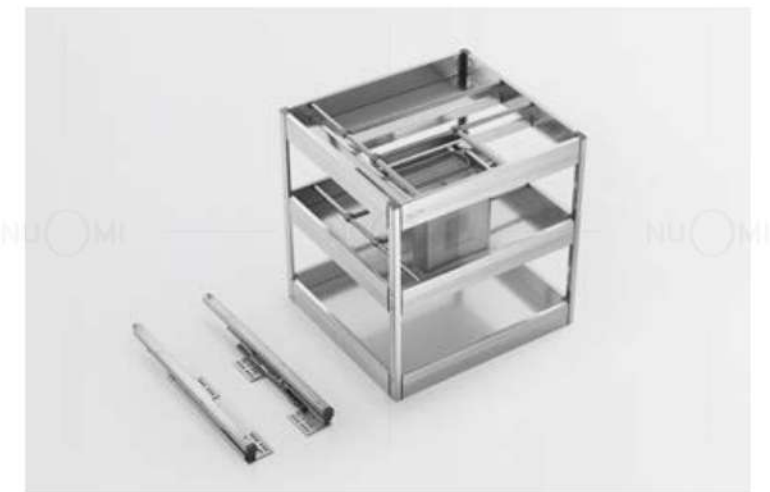

PULL-OUT BASKET FOR SEASONING 特拉斯调味篮



型号 Item No.	适用柜宽 (T) Cabinet width	宽度 x 深度 x 高度 Width x Depth x Height	材质 Material	表面 Surface	工艺 Process
3014001	400mm	350x450x490mm	不锈钢/SUS201	拉丝/Wire drawing	拉丝/Wire drawing

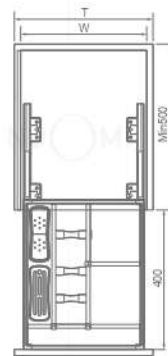

PULL-OUT BASKET FOR SEASONING 特拉斯调味篮



型号 Item No.	适用柜宽 (T) Cabinet width	宽度 x 深度 x 高度 Width x Depth x Height	材质 Material	表面 Surface	工艺 Process
3014002	400mm	350x450x490mm	不锈钢/SUS201	拉丝/Wire drawing	拉丝/Wire drawing

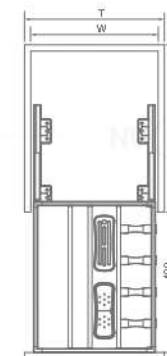

PULL-OUT BASKET FOR SEASONING 特拉斯调味篮



型号 Item No.	适用柜宽 (T) Cabinet width	宽度 x 深度 x 高度 Width x Depth x Height	材质 Material	表面 Surface	工艺 Process
3013501	350mm	300x450x490mm	不锈钢/SUS201	拉丝/Wire drawing	拉丝/Wire drawing

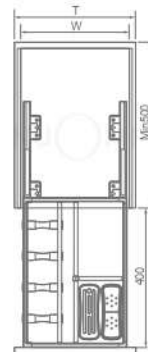

PULL-OUT BASKET FOR SEASONING 特拉斯调味篮



型号 Item No.	适用柜宽 (T) Cabinet width	宽度 x 深度 x 高度 Width x Depth x Height	材质 Material	表面 Surface	工艺 Process
3013002	300mm	250x450x490mm	不锈钢/SUS201	拉丝/Wire drawing	拉丝/Wire drawing

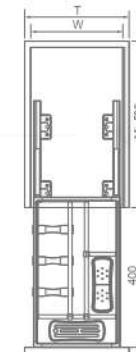

NARROW PULL-OUT BASKET 特拉斯窄边篮



型号 Item No.	适用柜宽 (T) Cabinet width	宽度 x 深度 x 高度 Width x Depth x Height	材质 Material	表面 Surface	工艺 Process
3012001	200mm	155x450x490mm	不锈钢/SUS201	拉丝/Wire drawing	拉丝/Wire drawing

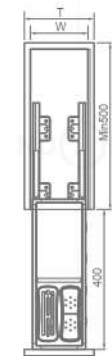

NARROW PULL-OUT BASKET 特拉斯窄边篮



型号 Item No.	适用柜宽 (T) Cabinet width	宽度 x 深度 x 高度 Width x Depth x Height	材质 Material	表面 Surface	工艺 Process
3011501	150mm	105x450x490mm	不锈钢/SUS201	拉丝/Wire drawing	拉丝/Wire drawing

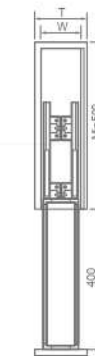



SIDE-MOUNTED BASKET UNDER SINK 特拉斯侧装水槽篮



型号 Item No.	适用柜宽 (T) Cabinet width	宽度 x 深度 x 高度 Width x Depth x Height	材质 Material	表面 Surface	工艺 Process
3012004	—	215x460x450mm	不锈钢 /SUS201	拉丝 /Wire drawing	拉丝 /Wire drawing

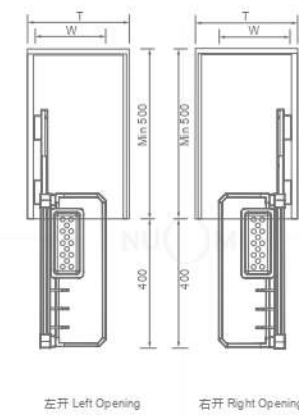



SIDE-MOUNTED BASKET UNDER SINK 特拉斯地柜联动篮



支架型号 Frame item No.	篮体型号 Basket item No.	适用柜宽 (T) Cabinet width	规格 (长 x 宽 x 高) Width x Depth x Height	描述 Description
2020007B	2020017	450mm	405x500x(600 以上 above)mm	左右共用 /Universal for left & right
2020008B	2020018	600mm	555x500x(600 以上 above)mm	左右共用 /Universal for left & right

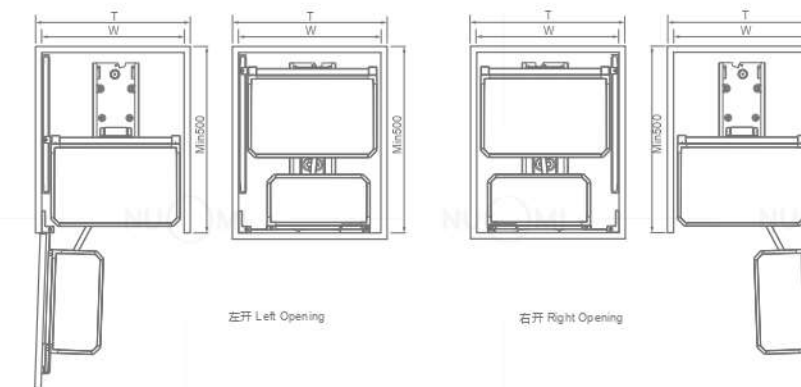

CHAMPAGNE ROSES

香槟玫瑰系列

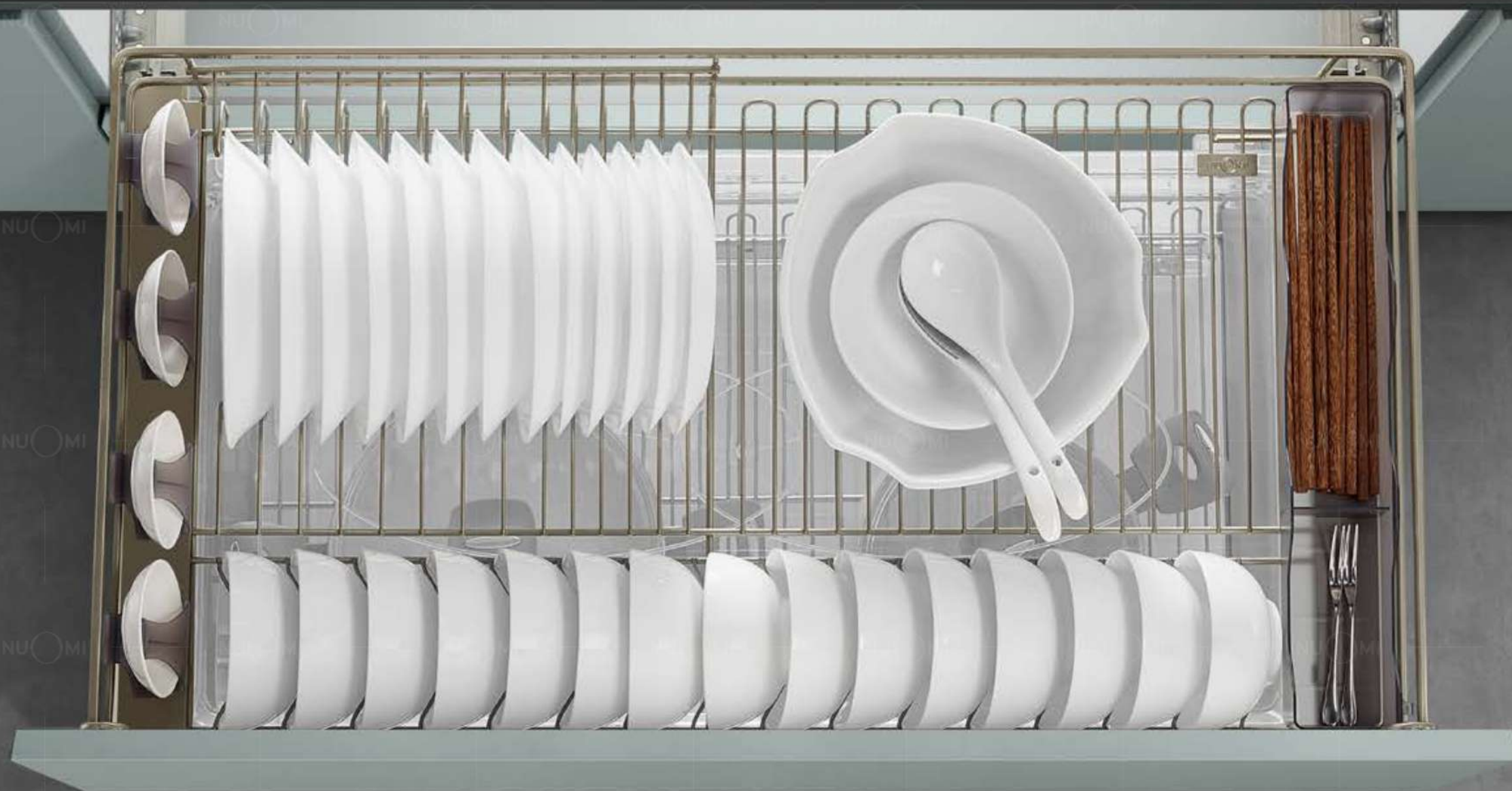



Corner units Function and technology 功能与技术

Function 功能

Store all kinds of kitchen utensils, kitchenware, condiments, cleaning articles etc. Make the kitchen clean and orderliness, clear at a glance, conveniently putting and taking items.

根据不同品种储存各类厨房器皿、用具、调味品、清洁用品等，厨房收纳整齐、一目了然、存放方便。

Quality 品质

Basket is made of superior steel with European style 4-layer nanometer dry plating, passes SGS salt spray test over 168 hours, never corrosion; Slide passes through European standard SGS80000 cycles test.

篮体采用优质钢材，表面经过欧标纳米干镀四层保护处理，能通过 168 小时盐雾测试，永不生锈；导轨通过欧标 SGS80000 次运动测试。

Design 设计

Standard with German soft-close slide, works smoothly and steady, silent and auto-close; Easily mounted with cabinet door, convenient for installation; European super wide flat wire, with water drop plastic tray, easily cleaning.

标配德国阻尼导轨，开合顺滑流畅，静音自动复位；拉篮采用快装门板设计，安装简易、方便；超宽扁线围边欧式风格，配接水盘，清洗方便。

Storage 储物

It is recommended to store different kinds of kitchenware, cooker, tableware, condiment according to different storage space.

建议根据不同区域储存各类厨房器皿、炊具、餐具、调味品等。

Loading Capacity 承重

Germany Brand HURMAR soft-close synchronous slide, Max loading: 30KG

德国品牌赫马阻尼缓冲同步导轨，可最大承重 30KG。



CORNER UNITS

转角系统

Let corner space reflect its charm fully, satisfy comfortable, practical, aesthetic 3 respects pursue, present an decorous, neat kitchen space for you.

让转角空间充分体现它的魅力，满足舒适、实用、审美三方面追求，为您呈现一个高雅、整洁的厨房空间。

180° ROTARY SHELF

180° 转盘





REVOLVING SAUCER 香槟玫瑰飞碟



型号 Item No.	适用柜宽 (T) Cabinet width	宽度 x 深度 x 高度 Width x Depth x Height	材质 Material	表面 Surface	工艺 Process	描述 Description
1020041	900mm	828x500x(620-720)mm	碳钢 / Carbon steel	香槟金 / Champagne gold	纳米干镀 / Dry plating	左开 / Left open
1020042	900mm	828x500x(620-720)mm	碳钢 / Carbon steel	香槟金 / Champagne gold	纳米干镀 / Dry plating	右开 / Right open

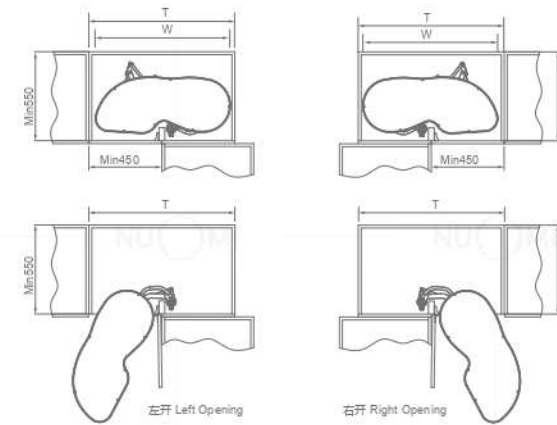



180° TURNTABLE SHELF 香槟玫瑰 180°转盘



型号 Item No.	适用柜宽 (T) Cabinet width	宽度 x 深度 x 高度 Width x Depth x Height	材质 Material	表面 Surface	工艺 Process
1030044	900mm	744x404x(620-720)mm	碳钢 / Carbon steel	香槟金 / Champagne gold	纳米干镀 / Dry plating

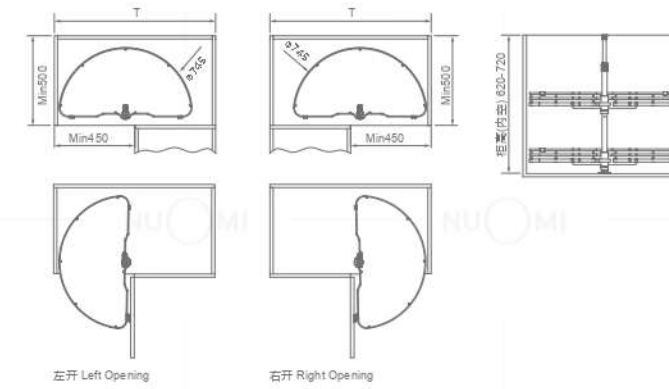



270° TURNABLE SHELF 香槟玫瑰 270°转盘



型号 Item No.	适用柜宽 (T) Cabinet width	宽度 x 深度 x 高度 Width x Depth x Height	材质 Material	表面 Surface	工艺 Process
1030043	900mm	φ710xH(620-720)mm	碳钢 / Carbon steel	香槟金 / Champagne gold	纳米干镀 / Dry plating

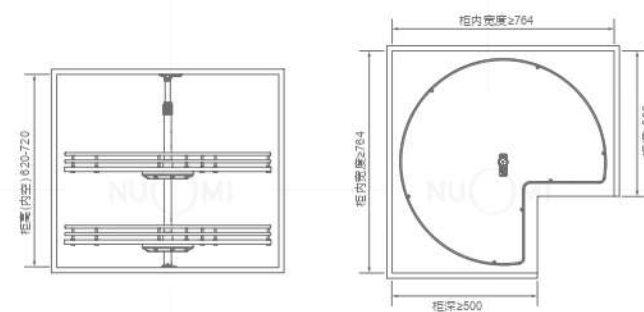



SOFT-CLOSE MAGIC CORNER 香槟玫瑰小怪物



支架型号 Frame item No.	篮体型号 Basket item No.	适用柜宽 (T) Cabinet width	规格 (长 x 宽 x 高) Width x Depth x Height	描述 Description
1010001C	1010040	900-1000mm	(860-960)x530x520mm	左开 /Left open
1010002C	1010040	900-1000mm	(860-960)x530x520mm	右开 /Right open

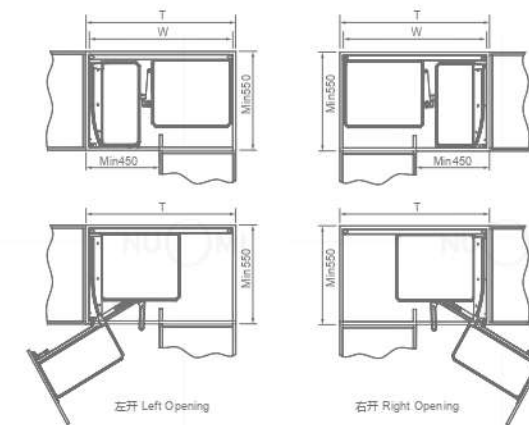

TALL CABINET STORAGE SYSTEM

高柜系统

NU MI

NU MI

NU MI

NU MI

NU MI

NU MI

NU MI

NU MI

NU MI

NU MI

NU MI

NU MI

NU MI

NU MI

NU MI

NU MI

NU MI

NU MI

NU MI

NU MI

NU MI

NU MI

NU MI

NU MI

NU MI

NU MI

NU MI

NU MI

NU MI

NU MI

NU MI

NU MI

NU MI

NU MI

NU MI

NU MI

NU MI

NU MI

NU MI

NU MI

NU MI

NU MI

NU MI

NU MI

NU MI

NU MI

NU MI

NU MI

NU MI

NU MI

NU MI

NU MI

NU MI

NU MI

NU MI

NU MI

NU MI

NU MI

Perfectly integrates the functions with daily usability, creating a truly extraordinary work by mixing various contradictions: a powerful functional hardware suitable for the kitchen to store a variety of items.

高柜系统将功能与日常实用性完美地融合在一起，通过融合各种矛盾，创造出真正的非凡之作：一款适合厨房收纳各种物品的性能强大的功能五金。

NU MI

NU MI

NU MI

NU MI

NU MI

NU MI

NU MI

NU MI

NU MI

NU MI





PANTRY ROLL-OUT 香槟玫瑰大怪物



支架型号 Frame item No.	篮体型号 Basket item No.	适用柜宽 (T) Cabinet width	规格 (长 x 宽 x 高) Width x Depth x Height	描述 Description
2020001C	2020041	450mm	405x500x(1180 以上 above)mm	4层 /Tiers
2020002C	2020042	450mm	405x500x(1430 以上 above)mm	5层 /Tiers
2020003C	2020043	450mm	405x500x(1780 以上 above)mm	6层 /Tiers
2020004C	2020044	600mm	555x500x(1180 以上 above)mm	4层 /Tiers
2020005C	2020045	600mm	555x500x(1430 以上 above)mm	5层 /Tiers
2020006C	2020046	600mm	555x500x(1780 以上 above)mm	6层 /Tiers

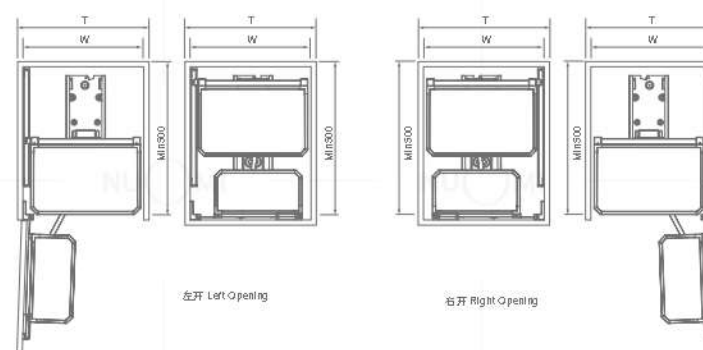



REVOLVING TALL UNIT 香槟玫瑰阻尼旋转高升篮



支架型号 (直拉式) Frame item No.(Straight Pull-out)	支架型号 (180°旋转) Frame item No.(180° Revolving)	篮体型号 Basket item No.	适用柜宽 (T) Cabinet width	规格 (长 x 宽 x 高) Width x Depth x Height	描述 Description
2010001E	2010001C	2010041	300mm	240x480x(1180-1480)mm	4层 /Tiers
2010002E	2010002C	2010042	300mm	240x480x(1430-1730)mm	5层 /Tiers
2010003E	2010003C	2010043	300mm	240x480x(1780-2080)mm	6层 /Tiers
2010001E	2010001C	2010044	400mm	340x480x(1180-1480)mm	4层 /Tiers
2010002E	2010002C	2010045	400mm	340x480x(1430-1730)mm	5层 /Tiers
2010003E	2010003C	2010046	400mm	340x480x(1780-2080)mm	6层 /Tiers

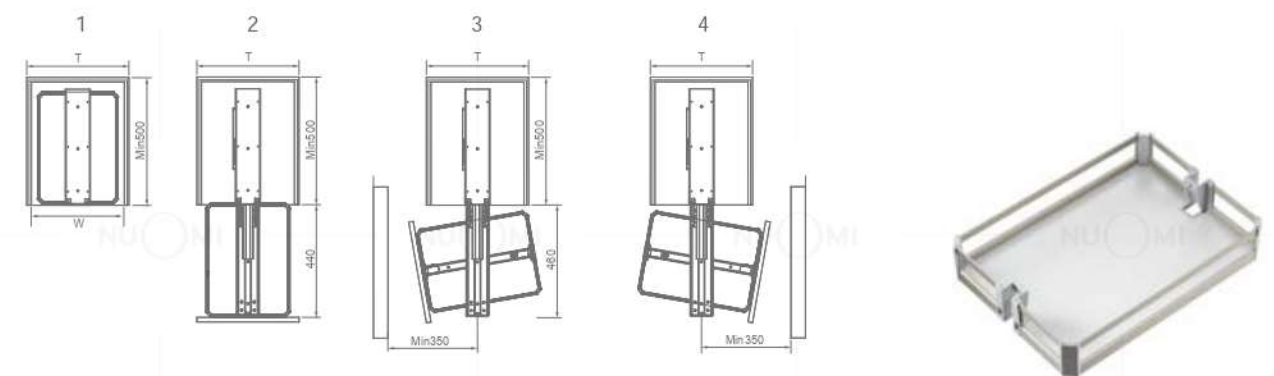

直拉式支架实现状态 /Straight Pull-out Tall Unit : 1、2
180°旋转支架实现状态 /180° Revolving Tall Unit : 1、2、3、4

BASE CABINET STORAGE SYSTEM

地柜系统

Minimalist, the pursuit of concise design. Return to the true nature of life, feel the warm experience and perfect enjoyment brought by the ultimate pursuit, experience the highest comfortable state of life.

极简臻品，追求精炼简洁设计。回归生活本真，用心感受极致追求带来的温馨体验和完美享受，体验生活最高舒适状态。





PULL-OUT BASKET 香槟玫瑰三边平篮



型号 Item No.	适用柜宽 (T) Cabinet width	宽度 x 深度 x 高度 Width x Depth x Height	材质 Material	表面 Surface	工艺 Process
3056001H	600mm	568x470x210mm	碳钢 / Carbon steel	香槟金 / Champagne gold	纳米干镀 / Dry plating
3057001H	700mm	668x470x210mm	碳钢 / Carbon steel	香槟金 / Champagne gold	纳米干镀 / Dry plating
3057201H	720mm	688x470x210mm	碳钢 / Carbon steel	香槟金 / Champagne gold	纳米干镀 / Dry plating
3057501H	750mm	718x470x210mm	碳钢 / Carbon steel	香槟金 / Champagne gold	纳米干镀 / Dry plating
3058001H	800mm	768x470x210mm	碳钢 / Carbon steel	香槟金 / Champagne gold	纳米干镀 / Dry plating
3059001H	900mm	868x470x210mm	碳钢 / Carbon steel	香槟金 / Champagne gold	纳米干镀 / Dry plating

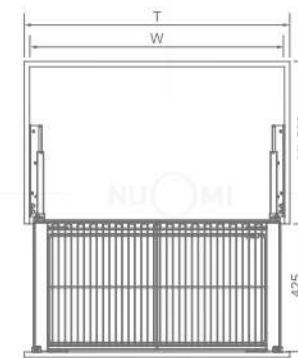



MULTIFUNCTIONAL PULL-OUT BASKET 香槟玫瑰三边碗碟篮



型号 Item No.	适用柜宽 (T) Cabinet width	宽度 x 深度 x 高度 Width x Depth x Height	材质 Material	表面 Surface	工艺 Process
3056002H	600mm	568x470x210mm	碳钢 / Carbon steel	香槟金 / Champagne gold	纳米干镀 / Dry plating
3057002H	700mm	668x470x210mm	碳钢 / Carbon steel	香槟金 / Champagne gold	纳米干镀 / Dry plating
3057202H	720mm	688x470x210mm	碳钢 / Carbon steel	香槟金 / Champagne gold	纳米干镀 / Dry plating
3057502H	750mm	718x470x210mm	碳钢 / Carbon steel	香槟金 / Champagne gold	纳米干镀 / Dry plating
3058002H	800mm	768x470x210mm	碳钢 / Carbon steel	香槟金 / Champagne gold	纳米干镀 / Dry plating
3059002H	900mm	868x470x210mm	碳钢 / Carbon steel	香槟金 / Champagne gold	纳米干镀 / Dry plating

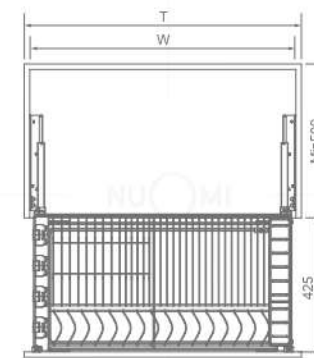



PULL-OUT BASKET FOR HINGE-DOOR (MOQ CUSTOM) 香槟玫瑰四边平篮 (批量定制)



型号 Item No.	适用柜宽 (T) Cabinet width	宽度 x 深度 x 高度 Width x Depth x Height	材质 Material	表面 Surface	工艺 Process
3056003H	600mm	568x470x182mm	碳钢 / Carbon steel	香槟金 / Champagne gold	纳米干镀 / Dry plating
3057003H	700mm	668x470x182mm	碳钢 / Carbon steel	香槟金 / Champagne gold	纳米干镀 / Dry plating
3057503H	750mm	718x470x182mm	碳钢 / Carbon steel	香槟金 / Champagne gold	纳米干镀 / Dry plating
3058003H	800mm	768x470x182mm	碳钢 / Carbon steel	香槟金 / Champagne gold	纳米干镀 / Dry plating
3059003H	900mm	868x470x182mm	碳钢 / Carbon steel	香槟金 / Champagne gold	纳米干镀 / Dry plating

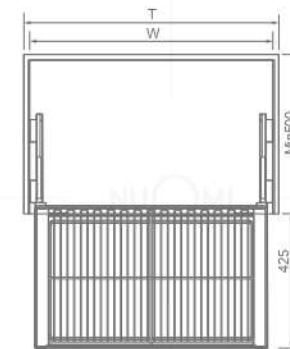



MULTIFUNCTIONAL PULL-OUT BASKET FOR HINGEDOOR(MOQ CUSTOM) 香槟玫瑰四边碗碟篮 (批量定制)



HURMAR
标配德国赫马阻尼导轨

型号 Item No.	适用柜宽 (T) Cabinet width	宽度 x 深度 x 高度 Width x Depth x Height	材质 Material	表面 Surface	工艺 Process
3056004H	600mm	568x470x182mm	碳钢 /Carbon steel	香槟金 /Champagne gold	纳米干镀 /Dry plating
3057004H	700mm	668x470x182mm	碳钢 /Carbon steel	香槟金 /Champagne gold	纳米干镀 /Dry plating
3057504H	750mm	718x470x182mm	碳钢 /Carbon steel	香槟金 /Champagne gold	纳米干镀 /Dry plating
3058004H	800mm	768x470x182mm	碳钢 /Carbon steel	香槟金 /Champagne gold	纳米干镀 /Dry plating
3059004H	900mm	868x470x182mm	碳钢 /Carbon steel	香槟金 /Champagne gold	纳米干镀 /Dry plating

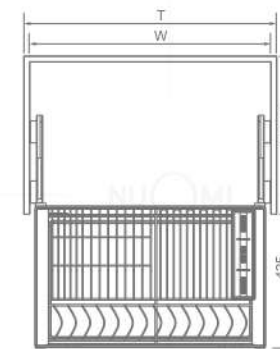

PULL-OUT BASKET FOR SEASONING

调味篮

Fashion is a kind of attitude to life, rather than complex boring, as simple life, do subtraction for life. Simplicity is fashion, and fashion is simplicity.

时尚是一种生活态度，与其复杂无趣，不如简单生活，为生活做减法。从简即时尚，时尚即简约。





Rich functions make kitchen life more elegant. Neat and efficient storage function, let you on all items at a glance, easy and efficient meal preparation. Experience life at its highest level of comfort.

丰富的功能让厨房生活更优雅。整洁高效的收纳功能，让您对所有物品一目了然，轻松高效地备餐。体验生活的最高舒适状态。

Kitchen Functional Hardware

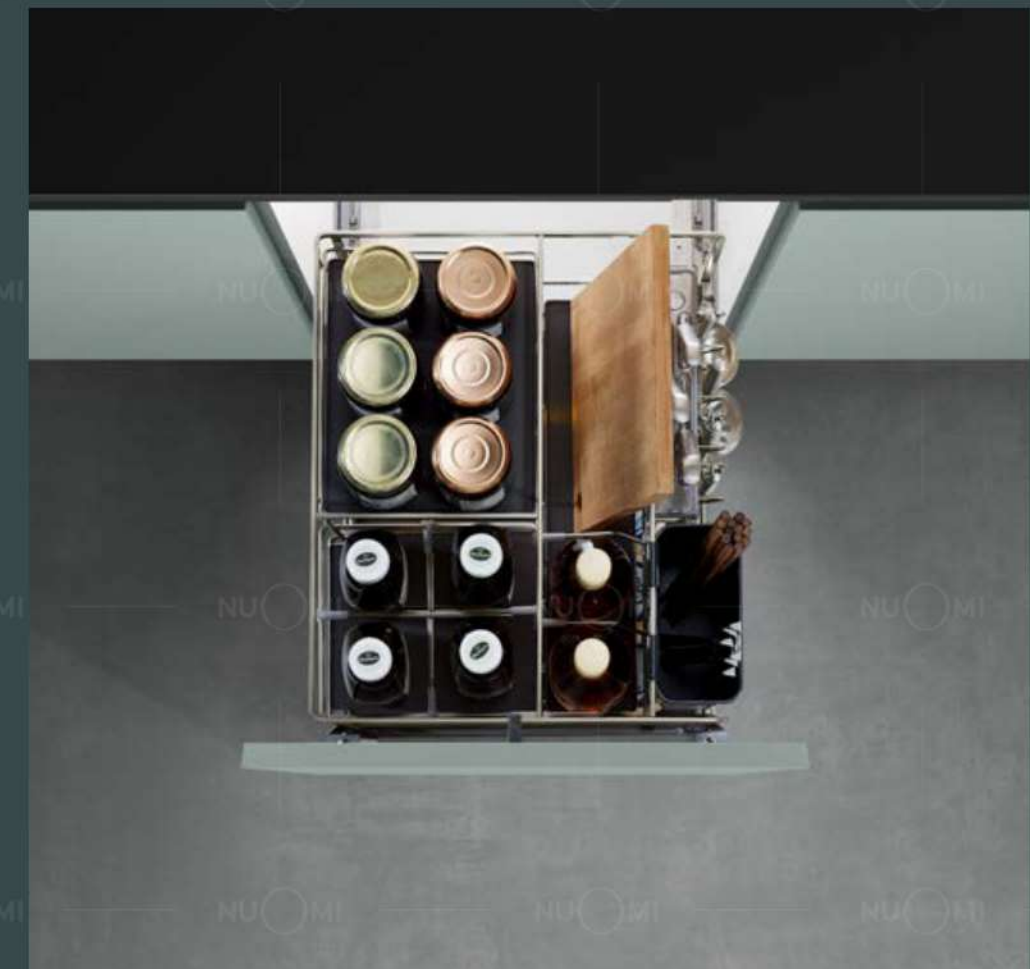



PULL-OUT BASKET FOR SEASONING 香槟玫瑰调味篮



型号 Item No.	适用柜宽 (T) Cabinet width	宽度 x 深度 x 高度 Width x Depth x Height	材质 Material	表面 Surface	工艺 Process
3054501H	450mm	414x460x480mm	碳钢 / Carbon steel	香槟金 / Champagne gold	纳米干镀 / Dry plating

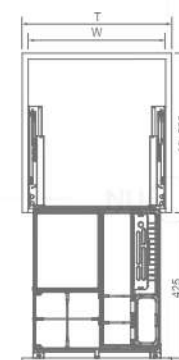

PULL-OUT BASKET FOR SEASONING 香槟玫瑰调味篮



PULL-OUT BASKET FOR SEASONING 香槟玫瑰调味篮



型号 Item No.	适用柜宽 (T) Cabinet width	宽度 x 深度 x 高度 Width x Depth x Height	材质 Material	表面 Surface	工艺 Process
3054001H	400mm	364x460x480mm	碳钢 /Carbon steel	香槟金 /Champagne gold	纳米干镀 /Dry plating
3053501H	350mm	314x460x480mm	碳钢 /Carbon steel	香槟金 /Champagne gold	纳米干镀 /Dry plating

型号 Item No.	适用柜宽 (T) Cabinet width	宽度 x 深度 x 高度 Width x Depth x Height	材质 Material	表面 Surface	工艺 Process
3053001H	300mm	264x460x480mm	碳钢 /Carbon steel	香槟金 /Champagne gold	纳米干镀 /Dry plating

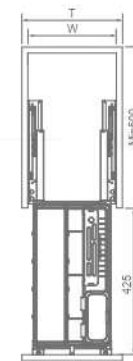
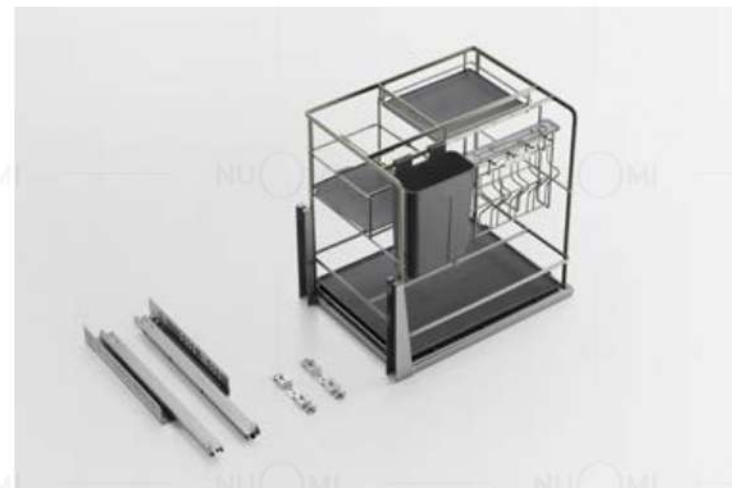
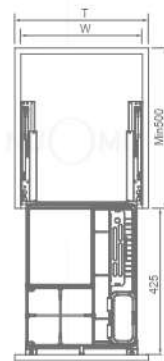

NARROW PULL-OUT BASKET 香槟玫瑰窄边篮



型号 Item No.	适用柜宽 (T) Cabinet width	宽度 x 深度 x 高度 Width x Depth x Height	材质 Material	表面 Surface	工艺 Process
3052001H	200mm	160x480x540mm	碳钢 /Carbon steel	香槟金 /Champagne gold	纳米干镀 /Dry plating
3051501H	150mm	110x480x540mm	碳钢 /Carbon steel	香槟金 /Champagne gold	纳米干镀 /Dry plating

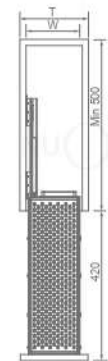

SIDE-MOUNTED BASKET UNDER SINK 香槟玫瑰侧装水槽篮



型号 Item No.	适用柜宽 (T) Cabinet width	宽度 x 深度 x 高度 Width x Depth x Height	材质 Material	表面 Surface	工艺 Process
3052004	—	215x460x450mm	碳钢 /Carbon steel	香槟金 /Champagne gold	纳米干镀 /Dry plating

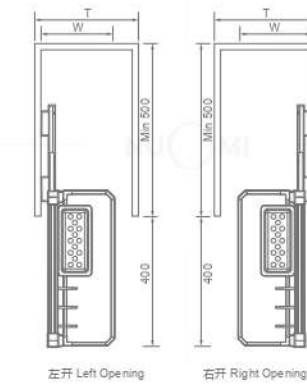



BASE CABINET MINI PANTRY ROLL-OUT 香槟玫瑰地柜联动篮



支架型号 Frame item No.	篮体型号 Basket item No.	适用柜宽 (T) Cabinet width	规格 (长 x 宽 x 高) Width x Depth x Height	描述 Description
2020007C	2020047	450mm	405x500x(600 以上 above)mm	左右共用 /Universal for left & right
2020008C	2020048	600mm	555x500x(600 以上 above)mm	左右共用 /Universal for left & right

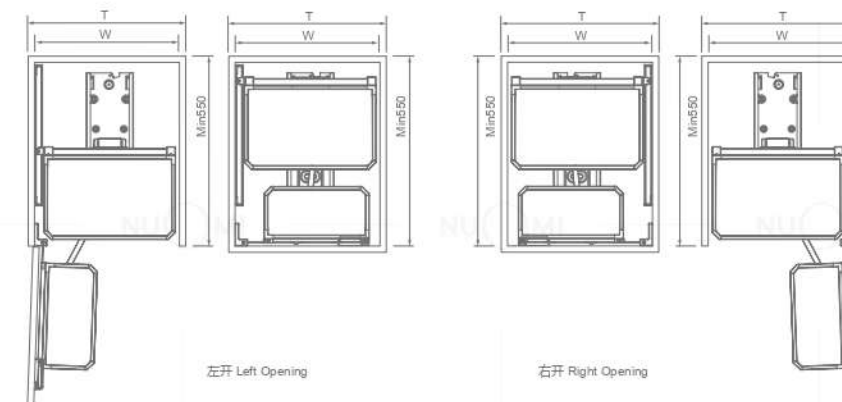

DAVARAJAS

金刚系列





Corner units Function and technology 功能与技术

Function 功能

Store all kinds of kitchen utensils,kitchenware,condiments,cleaing articles etc.Make the kitchen clean and orderliness,clear at a glance,conveniently putting and taking items.

根据不同品种储存各类厨房器皿、用具、调味品、清洁用品等，厨房收纳整齐、一目了然、存放方便。

Quality 品质

Basket is made of superior SUS304 stainless steel,with European style Trivalent chromium chromed,bright and durable;Slide passes through European standard SGS80000 cycles test.

篮体选用 SUS 304 不锈钢，表面经过欧标三价铬电镀，亮丽耐用；导轨通过欧标 SGS80000 次运动测试。

Design 设计

Standard with German soft-close slide,works smoothly and steady,silent and auto-close; Easily amountd with cabinet door, convenient for installation; European super wide flat wire, with water drop plastic tray, easily cleaning.

标配德国阻尼导轨，开合顺滑流畅，静音自动复位；拉篮采用快装门板设计，安装简易、方便；超宽扁线围边欧式风格，配接水盘，清洗方便。

Storage 储物

It is recommended to store different kinds of kitchenware,cooker,tableware,condiment according to different storage space.

建议根据不同区域储存各类厨房器皿、炊具、餐具、调味品等。

Loading Capacity 承重

Germany Brand HURMAR soft-close synchronous slide,Max loading:30KG

德国品牌赫马阻尼缓冲同步导轨，可最大承重 30KG。



CORNER UNITS

转角系统

270° ROTARY SHELF

270° 转盘



NUOMI corner unit, make the best use of corner space, easily pull out, convenient to fetch articles.

转角低柜深不可测，总要奋力将手往里伸。诺米转角系统，旋转之间，即可轻松查看取物。上下两层设计，合理利用空间。



REVOLVING SAUCER 金刚飞碟



型号 Item No.	适用柜宽 (T) Cabinet width	宽度 x 深度 x 高度 Width x Depth x Height	材质 Material	表面 Surface	工艺 Process	描述 Description
1020051	900mm	828x500x(620-720)mm	碳钢 /Carbon steel	镀铬银 /Chromed silver	电镀铬 /Electroplated	左开 /Left open
1020052	900mm	828x500x(620-720)mm	碳钢 /Carbon steel	镀铬银 /Chromed silver	电镀铬 /Electroplated	右开 /Right open

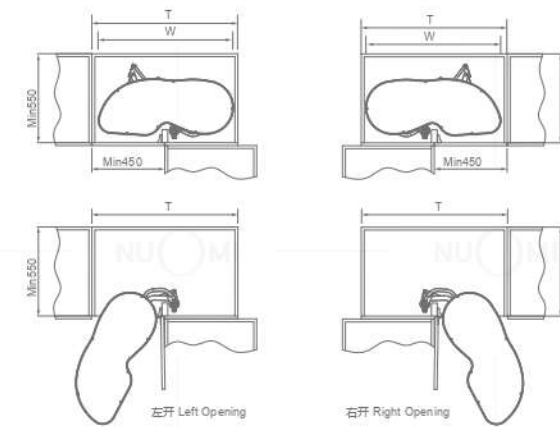



180° TURNTABLE SHELF 金刚 180°转盘



型号 Item No.	适用柜宽 (T) Cabinet width	宽度 x 深度 x 高度 Width x Depth x Height	材质 Material	表面 Surface	工艺 Process
1030054	900mm	744x404x(620-720)mm	碳钢/Carbon steel	镀铬银/Chromed silver	电镀铬/Electroplated

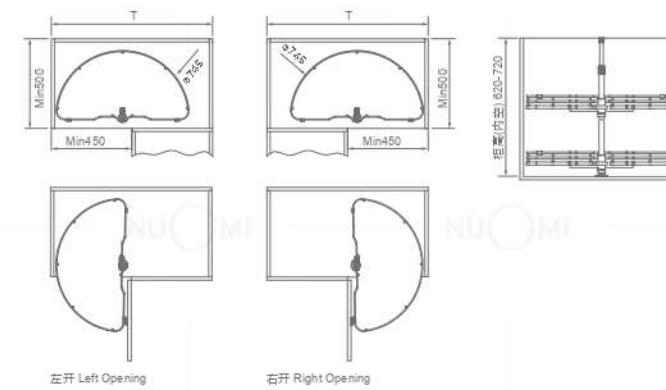



270° TURNTABLE SHELF 金刚 270°转盘



型号 Item No.	适用柜宽 (T) Cabinet width	宽度 x 深度 x 高度 Width x Depth x Height	材质 Material	表面 Surface	工艺 Process
1030053	900mm	φ710xH(620-720)mm	碳钢/Carbon steel	镀铬银/Chromed silver	电镀铬/Electroplated

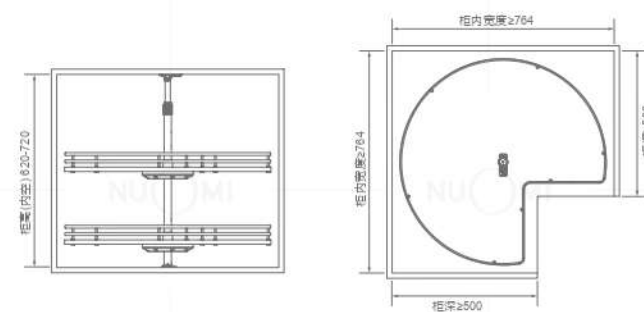



SOFT-CLOSE MAGIC CORNER 金刚小怪物

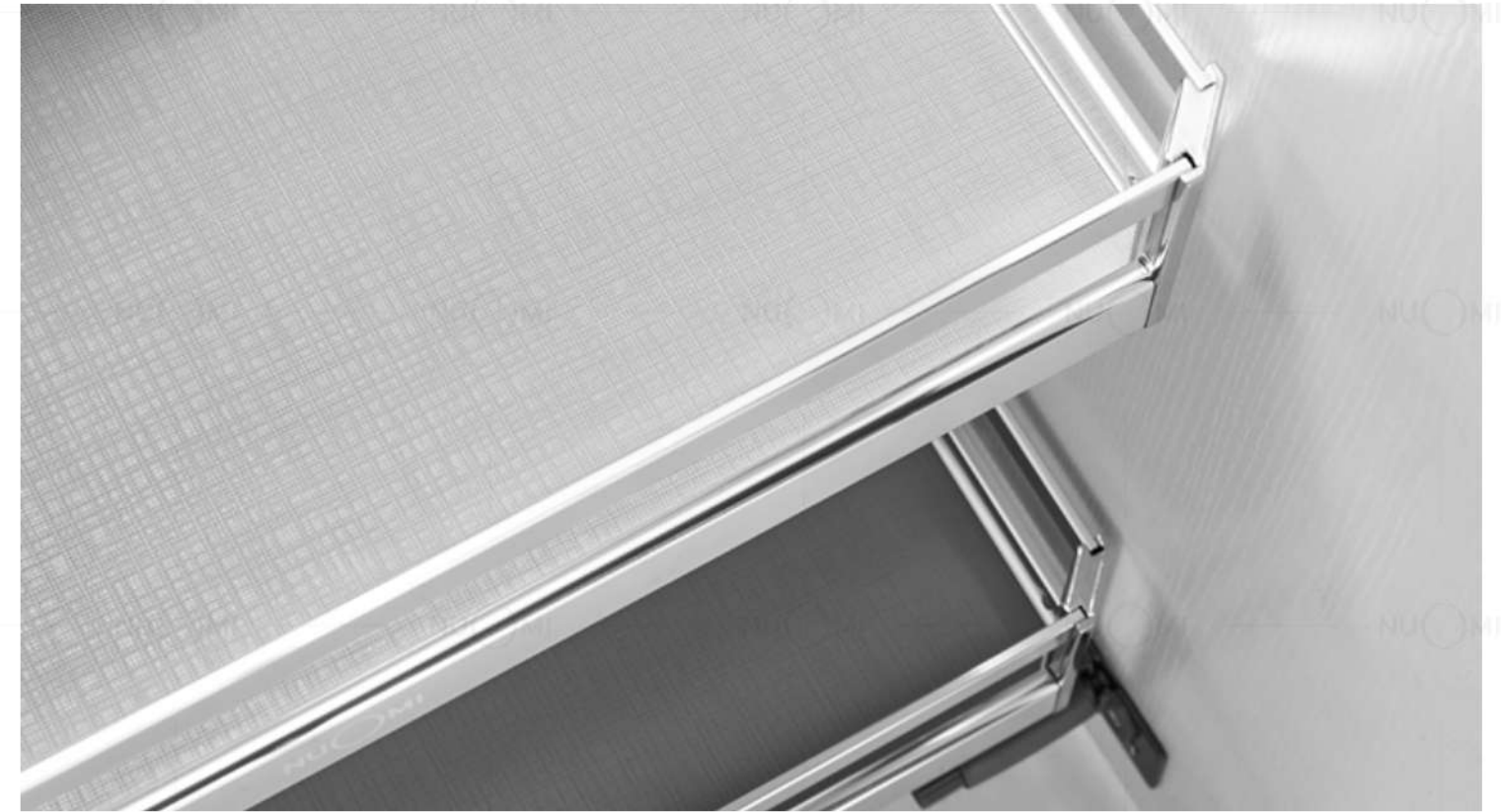

支架型号 Frame item No.	篮体型号 Basket item No.	适用柜宽 (T) Cabinet width	规格 (长 x 宽 x 高) Width x Depth x Height	描述 Description
1010001B	1010050	900-1000mm	(860-960)x530x520mm	左开 /Left open
1010002B	1010050	900-1000mm	(860-960)x530x520mm	右开 /Right open

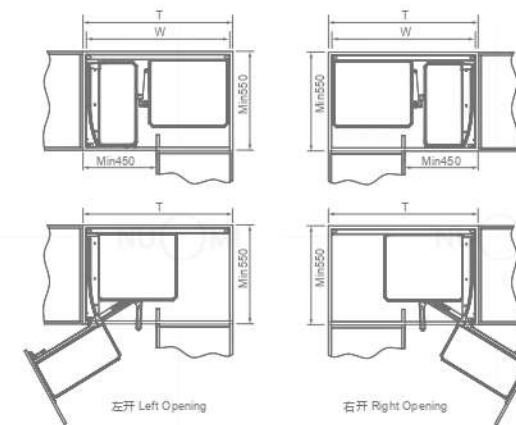

TALL CABINET STORAGE SYSTEM

高柜系统

Each slide builds a scenery line of life, and the hides its edge to show more stability. It represents the quality and attitude of life.

每一次滑动构建一道生活风景线，收敛了锋芒，多了一份沉稳。它代表着一种生活的品质与态度。





PANTRY ROLL-OUT 金刚大怪物



支架型号 Frame item No.	篮体型号 Basket item No.	适用柜宽 (T) Cabinet width	规格 (长 x 宽 x 高) Width x Depth x Height	描述 Description
2020001B	2020051	450mm	405x500x(1180 以上 above)mm	4层 /Tiers
2020002B	2020052	450mm	405x500x(1430 以上 above)mm	5层 /Tiers
2020003B	2020053	450mm	405x500x(1780 以上 above)mm	6层 /Tiers
2020004B	2020054	600mm	555x500x(1180 以上 above)mm	4层 /Tiers
2020005B	2020055	600mm	555x500x(1430 以上 above)mm	5层 /Tiers
2020006B	2020056	600mm	555x500x(1780 以上 above)mm	6层 /Tiers

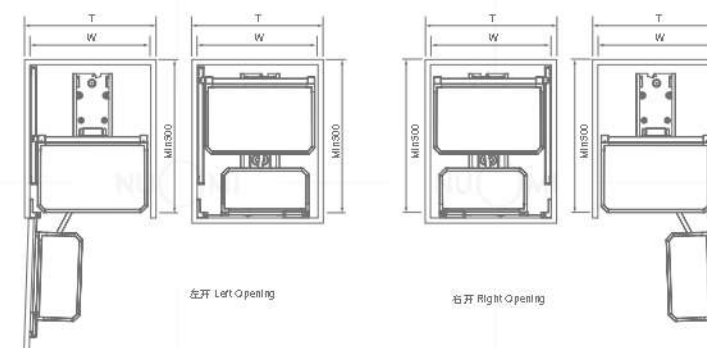



AIRCRAFT CARRIER CABIN 金刚航母台



支架型号 Frame item No.	篮体型号 Basket item No.	适用柜宽 (T) Cabinet width	规格 (长 x 宽 x 高) Width x Depth x Height	描述 Description
2030001B	2030051A	450mm	(404-424)x500x1430mm	4层 /Tiers
2030001B	2030052A	600mm	(554-574)x500x1430mm	4层 /Tiers
2030002B	2030053A	450mm	(404-424)x500x1780mm	5层 /Tiers
2030002B	2030054A	600mm	(554-574)x500x1780mm	5层 /Tiers

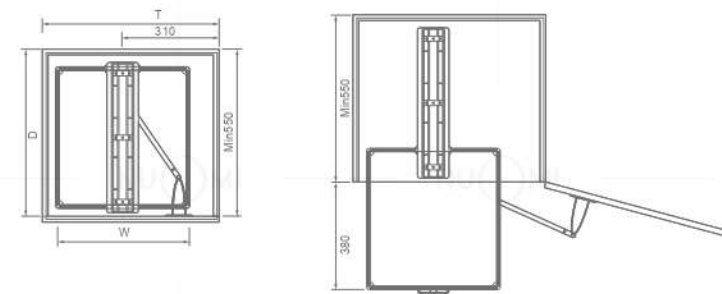

建议门板使用 165°铰链
Suggesting cabinet door being mounted with 165° hinge





REVOLVING TALL UNIT 金刚阻尼旋转高身篮



支架型号 (直拉式) Frame item No.(Straight Pull-out)	支架型号 (180°旋转) Frame item No.(180° Revolving)	篮体型号 Basket item No.	适用柜宽 (T) Cabinet width	规格 (长 x 宽 x 高) Width x Depth x Height	描述 Description
2010001D	2010001B	2010051	300mm	240x480x(1180-1480)mm	4层 /Tiers
2010002D	2010002B	2010052	300mm	240x480x(1430-1730)mm	5层 /Tiers
2010003D	2010003B	2010053	300mm	240x480x(1780-2080)mm	6层 /Tiers
2010001D	2010001B	2010054	400mm	340x480x(1180-1480)mm	4层 /Tiers
2010002D	2010002B	2010055	400mm	340x480x(1430-1730)mm	5层 /Tiers
2010003D	2010003B	2010056	400mm	340x480x(1780-2080)mm	6层 /Tiers

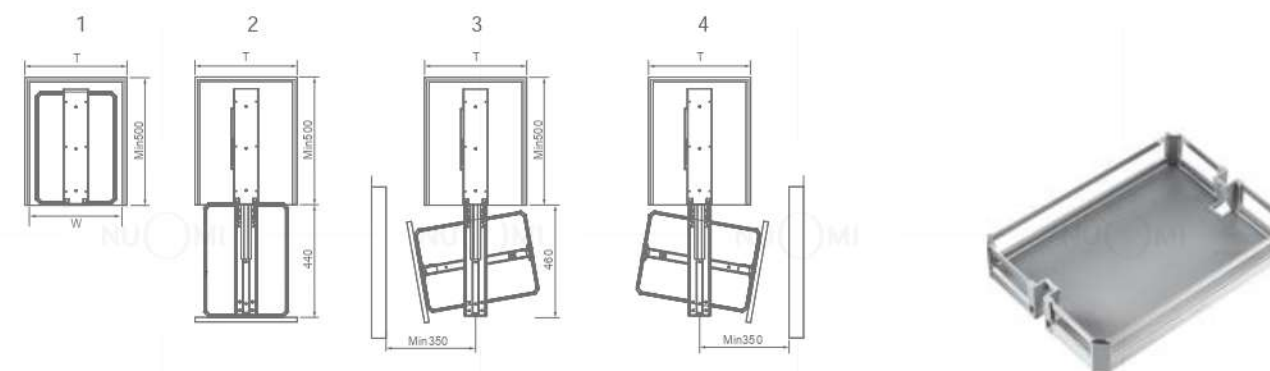

直拉式支架实现状态 /Straight Pull-out Tall Unit : 1、2
180°旋转支架实现状态 /180° Revolving Tall Unit : 1、2、3、4

BASE CABINET STORAGE SYSTEM

地柜系统

A tidy kitchen, make your heart peaceful. Keep orderly life,
completely control no matter inside or outside.

整理出一个整洁宽敞的厨房，也整理出一颗平静豁达的内心。生活
的步履不乱，于内于外，都是充分的掌控。





PULL-OUT BASKET 金刚三边平篮



型号 Item No.	适用柜宽 (T) Cabinet width	宽度 x 深度 x 高度 Width x Depth x Height	材质 Material	表面 Surface	工艺 Process
3126001H	600mm	568x470x210mm	不锈钢/SUS304	镀铬银 /Chromed silver	电镀铬 /Electroplated
3127001H	700mm	668x470x210mm	不锈钢/SUS304	镀铬银 /Chromed silver	电镀铬 /Electroplated
3127201H	720mm	688x470x210mm	不锈钢/SUS304	镀铬银 /Chromed silver	电镀铬 /Electroplated
3127501H	750mm	718x470x210mm	不锈钢/SUS304	镀铬银 /Chromed silver	电镀铬 /Electroplated
3128001H	800mm	768x470x210mm	不锈钢/SUS304	镀铬银 /Chromed silver	电镀铬 /Electroplated
3129001H	900mm	868x470x210mm	不锈钢/SUS304	镀铬银 /Chromed silver	电镀铬 /Electroplated

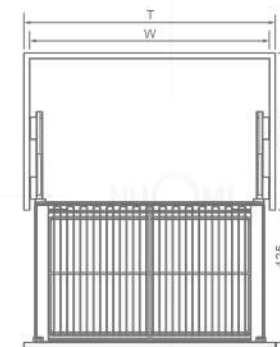



MULTIFUNCTIONAL PULL-OUT UNIT 金刚三边碗碟篮

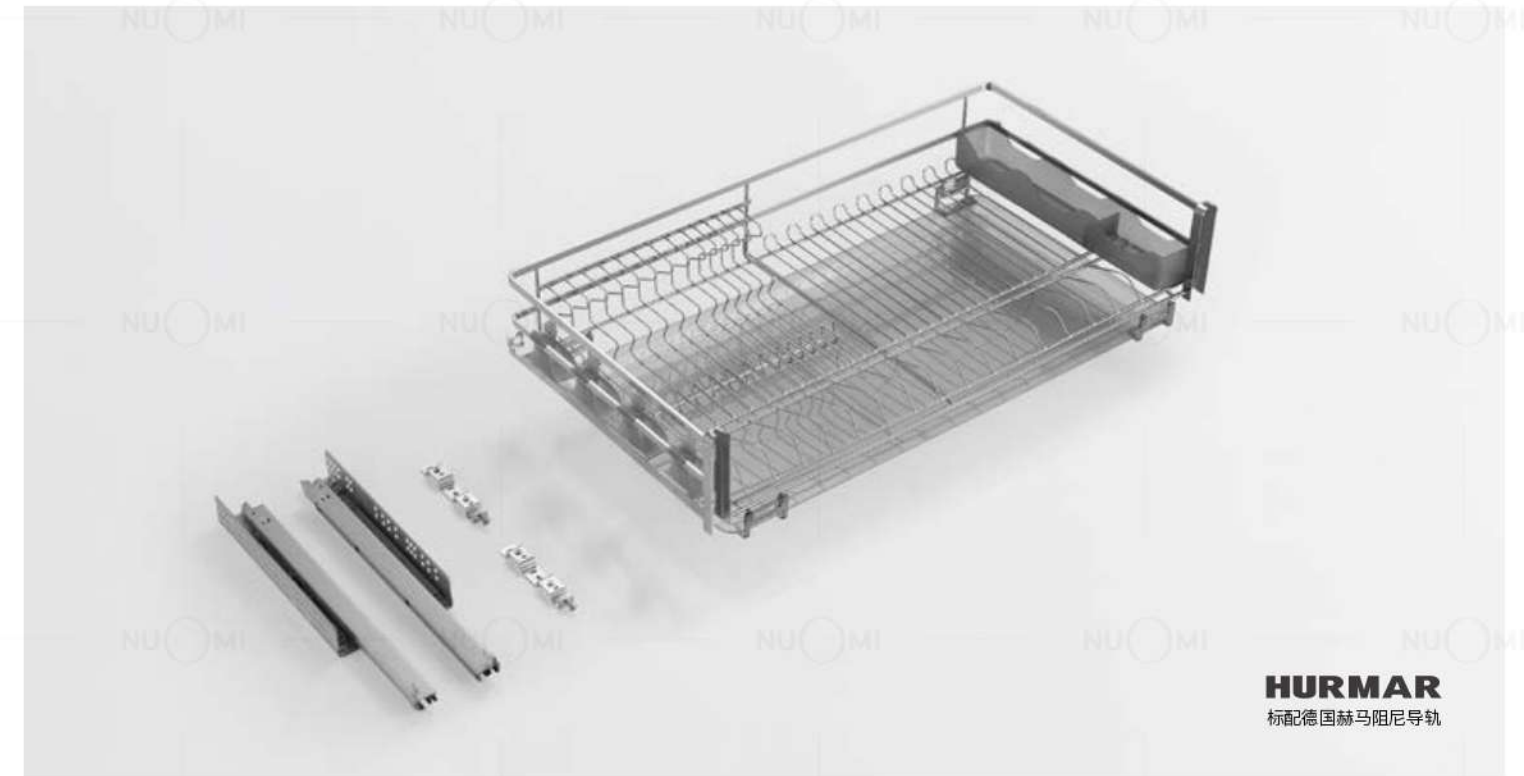

型号 Item No.	适用柜宽 (T) Cabinet width	宽度 x 深度 x 高度 Width x Depth x Height	材质 Material	表面 Surface	工艺 Process
3126002H	600mm	568x470x210mm	不锈钢/SUS304	镀铬银 /Chromed silver	电镀铬 /Electroplated
3127002H	700mm	668x470x210mm	不锈钢/SUS304	镀铬银 /Chromed silver	电镀铬 /Electroplated
3127202H	720mm	688x470x210mm	不锈钢/SUS304	镀铬银 /Chromed silver	电镀铬 /Electroplated
3127502H	750mm	718x470x210mm	不锈钢/SUS304	镀铬银 /Chromed silver	电镀铬 /Electroplated
3128002H	800mm	768x470x210mm	不锈钢/SUS304	镀铬银 /Chromed silver	电镀铬 /Electroplated
3129002H	900mm	868x470x210mm	不锈钢/SUS304	镀铬银 /Chromed silver	电镀铬 /Electroplated

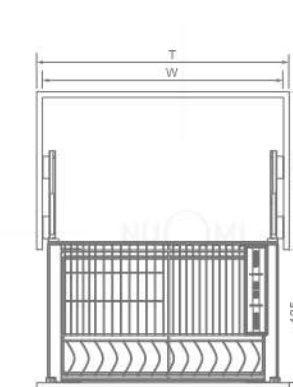

PULL-OUT BASKET FOR SEASONING

调味篮

Exclusive area, easy to tidy up. Each item has its own place, so you don't have to worry about how to put it, and you can easily put it away.

专属区域，轻松整理。每种物品都有专属位置，不用费心研究怎么摆放，轻轻松松就能整齐收纳。





Kitchen
Functional
Hardware

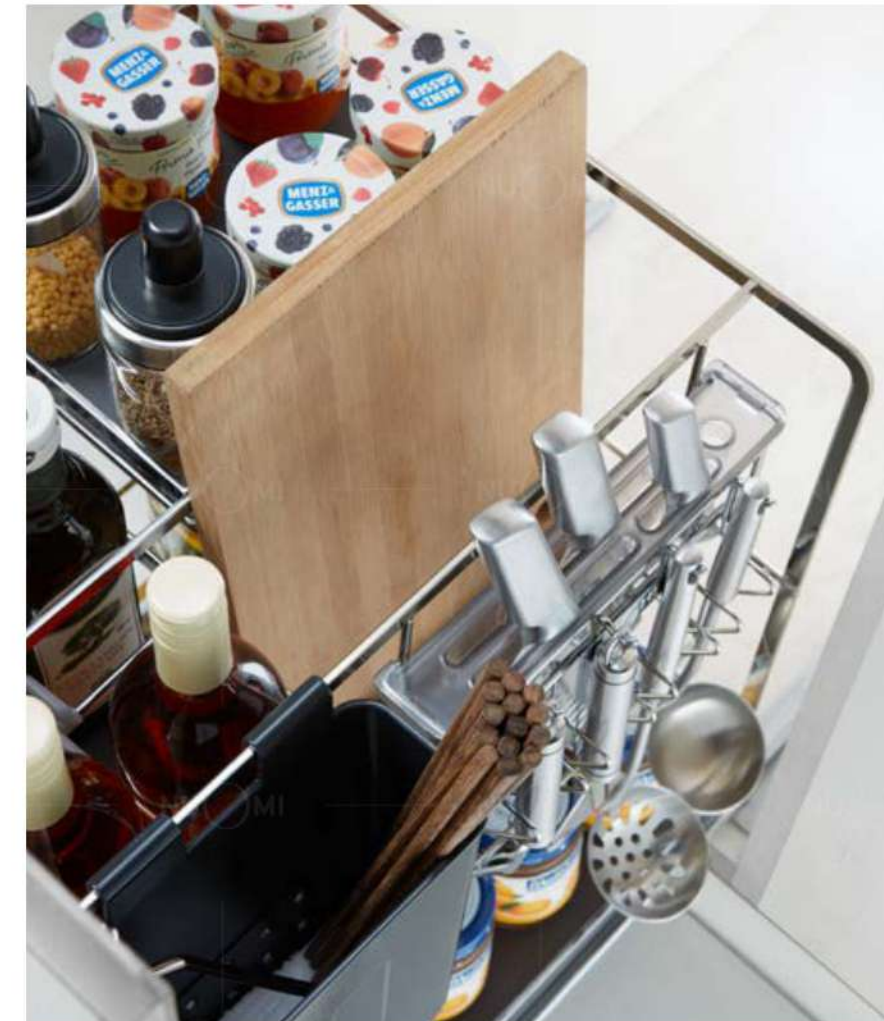



PULL-OUT BASKET FOR SEASONING 金刚调味篮



HURMAR
标配德国赫马尼导轨

型号 Item No.	适用柜宽 (T) Cabinet width	宽度 x 深度 x 高度 Width x Depth x Height	材质 Material	表面 Surface	工艺 Process
3124501H	450mm	414x460x480mm	不锈钢 /SUS304	镀铬银 /Chromed silver	电镀铬 /Electroplated

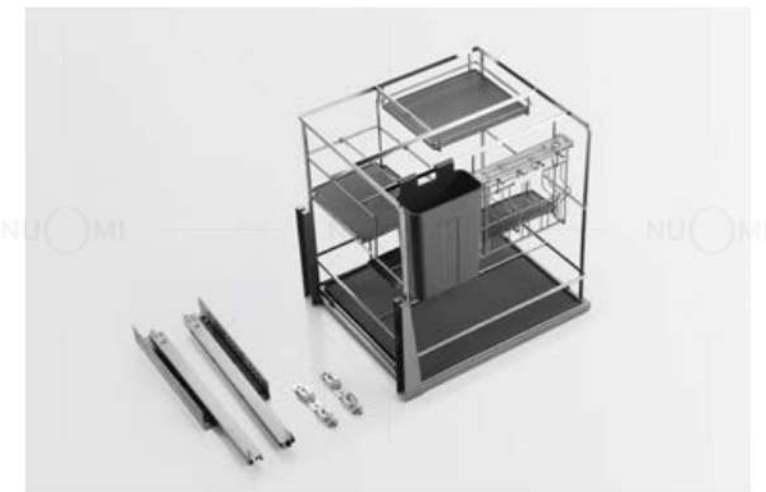
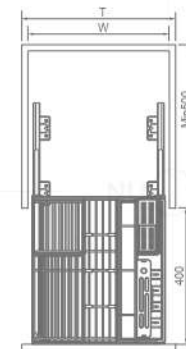



型号 Item No.	适用柜宽 (T) Cabinet width	宽度 x 深度 x 高度 Width x Depth x Height	材质 Material	表面 Surface	工艺 Process
3124001H	400mm	364x460x480mm	不锈钢 /SUS304	镀铬银 /Chromed silver	电镀铬 /Electroplated

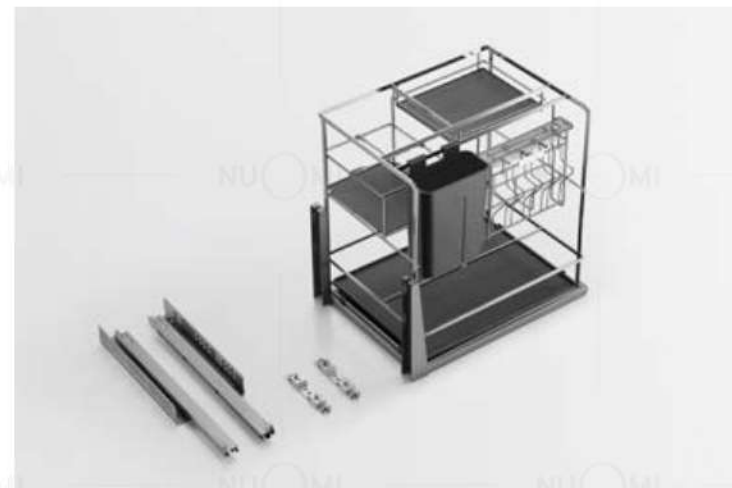

型号 Item No.	适用柜宽 (T) Cabinet width	宽度 x 深度 x 高度 Width x Depth x Height	材质 Material	表面 Surface	工艺 Process
3123501H	350mm	314x460x480mm	不锈钢 /SUS304	镀铬银 /Chromed silver	电镀铬 /Electroplated
3123001H	300mm	264x460x480mm	不锈钢 /SUS304	镀铬银 /Chromed silver	电镀铬 /Electroplated

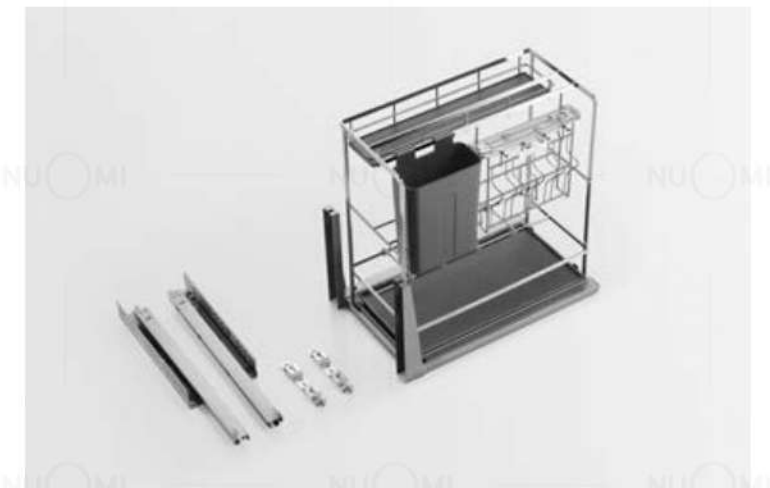
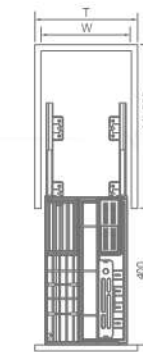

NARROW PULL-OUT BASKET 金刚窄边篮



型号 Item No.	适用柜宽 (T) Cabinet width	宽度 x 深度 x 高度 Width x Depth x Height	材质 Material	表面 Surface	工艺 Process
3121501H	150mm	110x480x540mm	不锈钢 /SUS304	镀铬银 /Chromed silver	电镀铬 /Electroplated

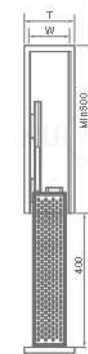

SIDE-MOUNTED BASKET UNDER SINK 金刚侧装水槽篮



型号 Item No.	适用柜宽 (T) Cabinet width	宽度 x 深度 x 高度 Width x Depth x Height	材质 Material	表面 Surface	工艺 Process
3062004	—	215x460x450mm	太空合金 /Aluminium	镀铬银 /Chromed silver	电镀铬 /Electroplated

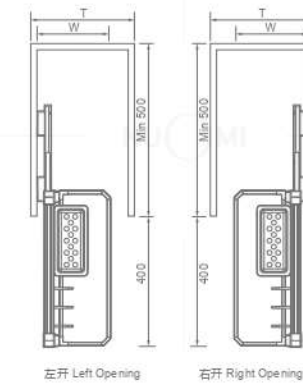



BASE CABINET MINI PANTRY ROLL-OUT 金刚地柜联动篮



支架型号 Frame item No.	篮体型号 Basket item No.	适用柜宽 (T) Cabinet width	规格 (长 x 宽 x 高) Width x Depth x Height	描述 Description
2020007B	2020057	450mm	405x500x(600 以上 above)mm	左右共用 /Universal for left & right
2020008B	2020058	600mm	555x500x(600 以上 above)mm	左右共用 /Universal for left & right

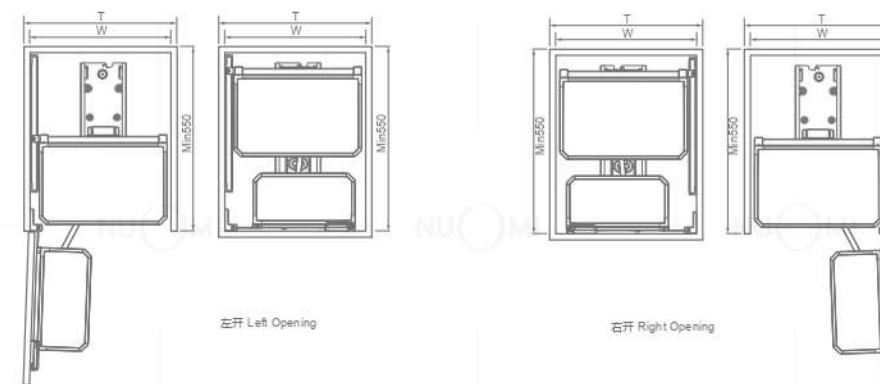



VISCOUNT-X

银爵 X 系列



Corner units Function and technology 功能与技术

Function 功能

Store all kinds of kitchen utensils,kitchenware,condiments,cleaing articles etc.Make the kitchen clean and orderliness,clear at a glance,conveniently putting and taking items.

根据不同品种储存各类厨房器皿、用具、调味品、清洁用品等，厨房收纳整齐、一目了然、存放方便。

Quality 品质

Basket is made of superior steel with European style Trivalent chromium chromed,bright and durable;Slide passes through European standard SGS80000 cycles test.

篮体采用优质钢材，表面经过欧标三价铬电镀，亮丽耐用；导轨通过欧标 SGS80000 次运动测试。

Design 设计

Standard with NUOMI soft-close slide,works smoothly and steady,silent and auto-close; Easily amountd with cabinet door, convenient for installation; Exquisite round wire shows fashionable style, with water drop plastic tray, easily cleaning.

标配诺米阻尼导轨，开合顺滑流畅，静音自动复位；拉篮采用快装门板设计，安装简易、方便；精致圆线围边演绎时尚风格，配接水盘，清洗方便。

Storage 储物

It is recommended to store different kinds of kitchenware,cooker,tableware,condiment according to different storage space.

建议根据不同区域储存各类厨房器皿、炊具、餐具、调味品等。

Loading Capacity 承重

Max loading:30KG

可最大承重 30KG。

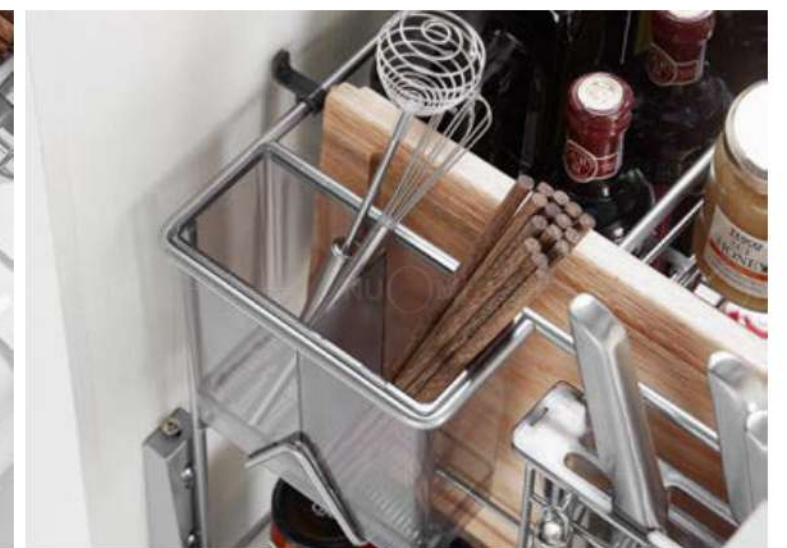



PULL-OUT BASKET 银爵 X 三边平篮

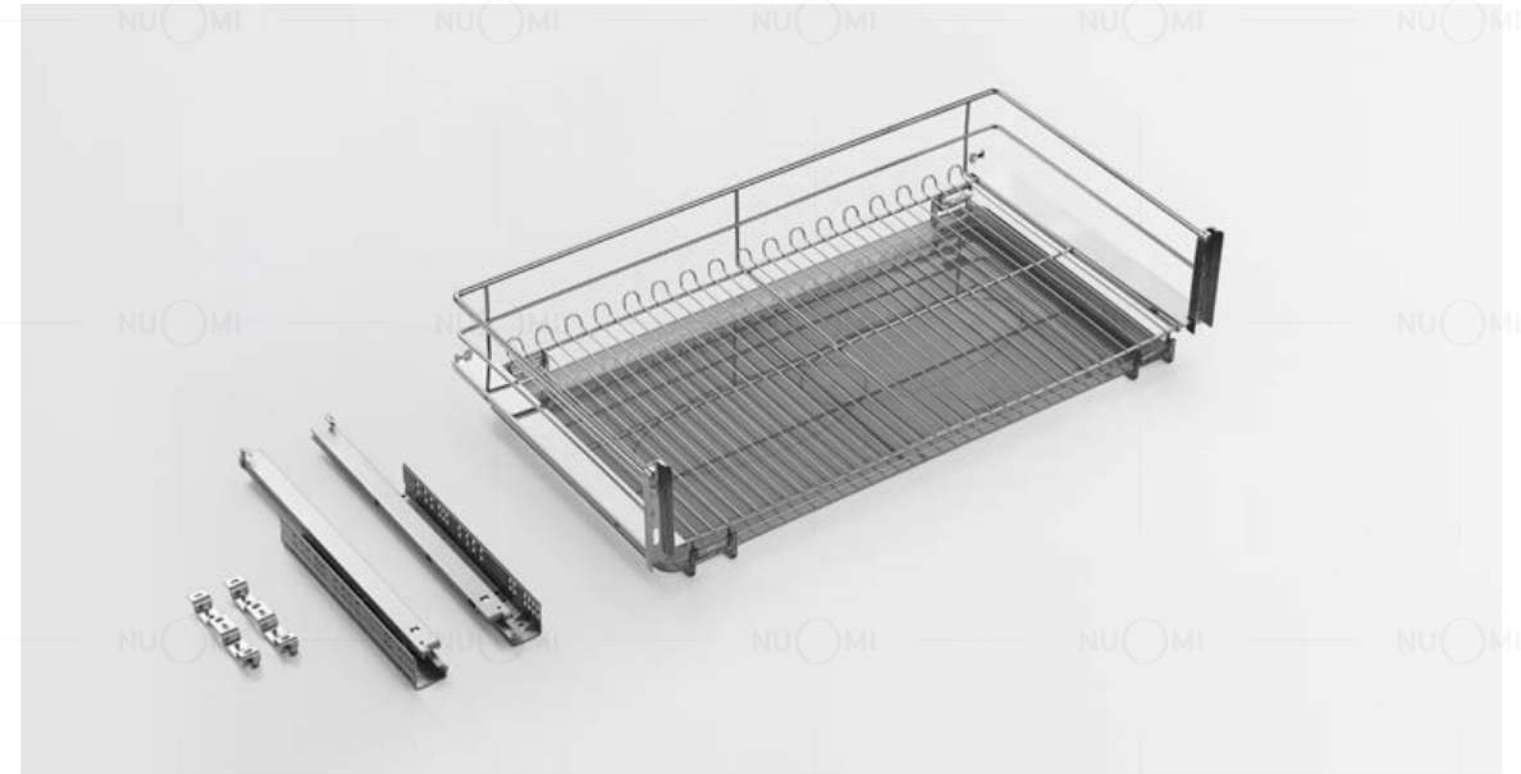

型号 Item No.	适用柜宽 (T) Cabinet width	宽度 x 深度 x 高度 Width x Depth x Height	材质 Material	工艺 Process
3166001	600mm	564x470x200mm	碳钢 / Carbon steel	纳米干镀 / Dry plating
3167001	700mm	664x470x200mm	碳钢 / Carbon steel	纳米干镀 / Dry plating
3167201	720mm	684x470x200mm	碳钢 / Carbon steel	纳米干镀 / Dry plating
3167501	750mm	714x470x200mm	碳钢 / Carbon steel	纳米干镀 / Dry plating
3168001	800mm	764x470x200mm	碳钢 / Carbon steel	纳米干镀 / Dry plating
3169001	900mm	864x470x200mm	碳钢 / Carbon steel	纳米干镀 / Dry plating

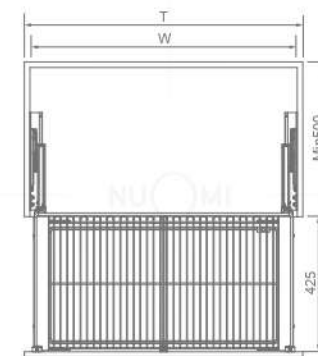



MULTIFUNCTIONAL PULL-OUT BASKET 银爵 X 三边碗碟篮



型号 Item No.	适用柜宽 (T) Cabinet width	宽度 x 深度 x 高度 Width x Depth x Height	材质 Material	工艺 Process
3166002	600mm	564x470x200mm	碳钢 / Carbon steel	纳米干镀 / Dry plating
3167002	700mm	664x470x200mm	碳钢 / Carbon steel	纳米干镀 / Dry plating
3167202	720mm	684x470x200mm	碳钢 / Carbon steel	纳米干镀 / Dry plating
3167502	750mm	714x470x200mm	碳钢 / Carbon steel	纳米干镀 / Dry plating
3168002	800mm	764x470x200mm	碳钢 / Carbon steel	纳米干镀 / Dry plating
3169002	900mm	864x470x200mm	碳钢 / Carbon steel	纳米干镀 / Dry plating

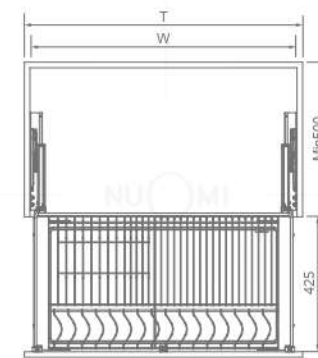



PULL-OUT BASKET FOR SEASONING 银爵 X 调味篮

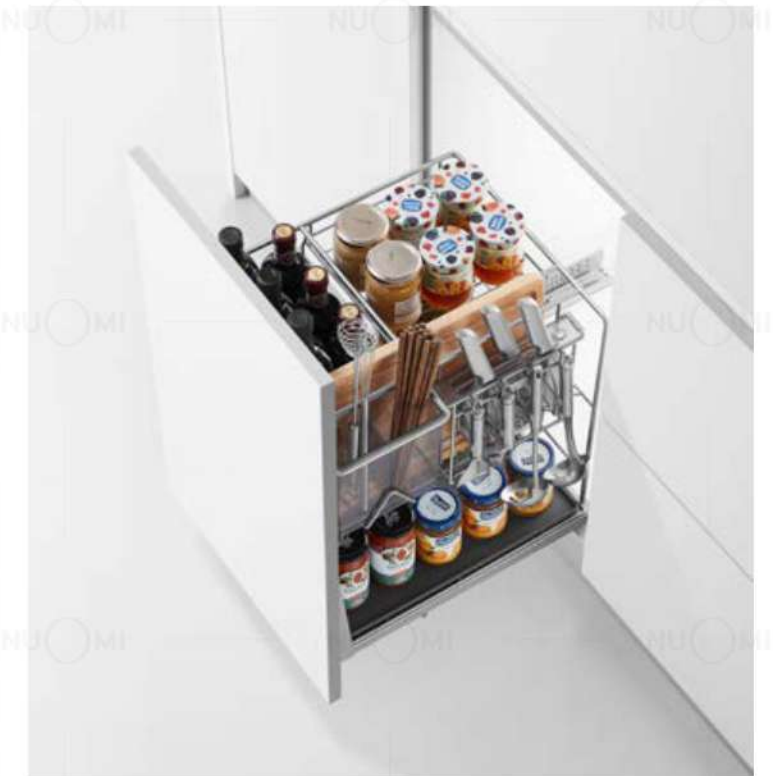

型号 Item No.	适用柜宽 (T) Cabinet width	宽度 x 深度 x 高度 Width x Depth x Height	材质 Material	工艺 Process
3164501	450mm	385x460x495mm	碳钢 / Carbon steel	纳米干镀 / Dry plating
3164001	400mm	335x460x495mm	碳钢 / Carbon steel	纳米干镀 / Dry plating

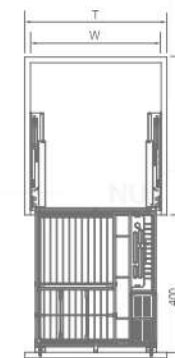



PULL-OUT BASKET FOR SEASONING 银爵 X 调味篮



型号 Item No.	适用柜宽 (T) Cabinet width	宽度 x 深度 x 高度 Width x Depth x Height	材质 Material	工艺 Process
3163501	350mm	285x460x495mm	碳钢 / Carbon steel	纳米干镀 / Dry plating
3163001	300mm	235x460x495mm	碳钢 / Carbon steel	纳米干镀 / Dry plating

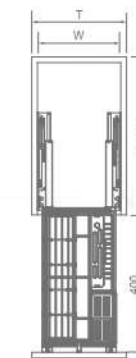

OTHER KITCHEN STORAGE PRODUCT

配套产品



GUSTAFUNCTIONAL COLOR
古斯特系列可选颜色

CHAMPAGNE GOLD/HIGHCLASS GREY
香槟金 / 太郎灰

GUSTA
古斯特系列

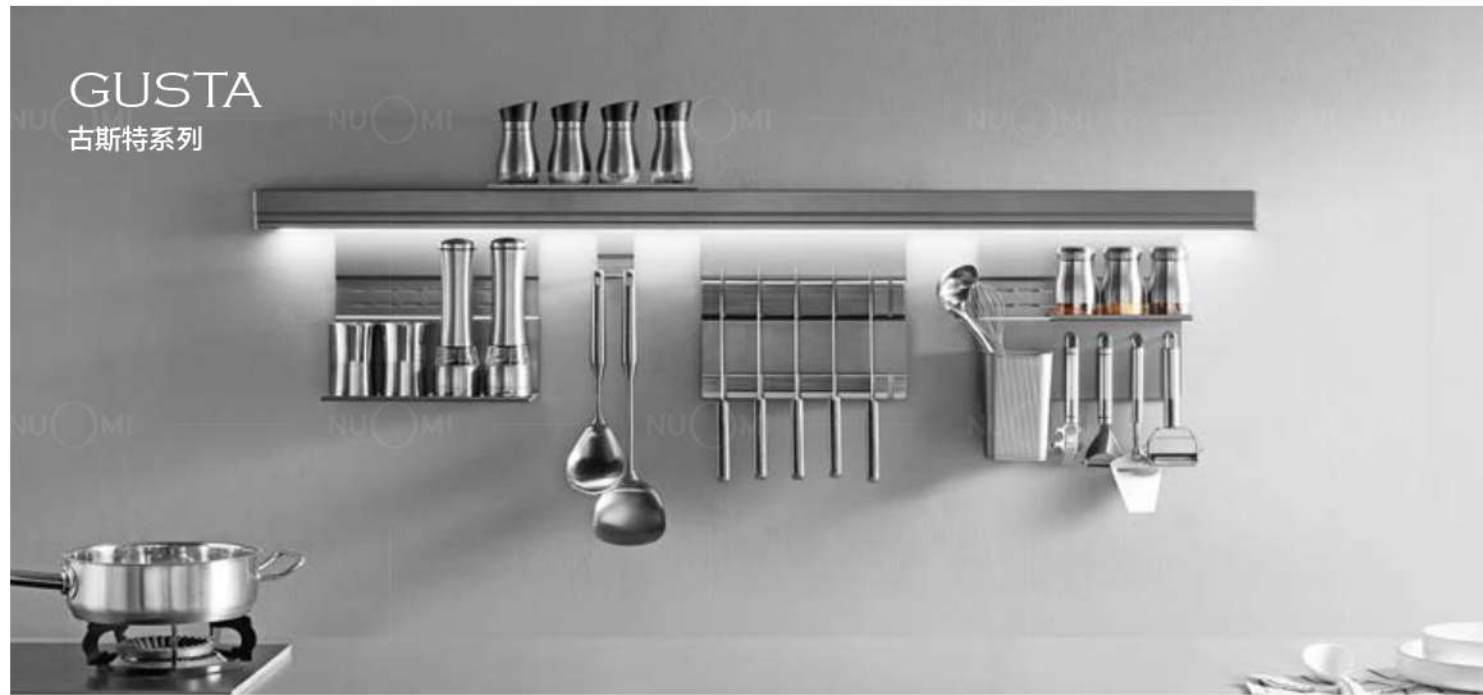

名称 Name	挂杆型号 Item No.(hanging bar)	名称 Name	套餐型号 Item No.(rack set)	长度 Length	
	香槟金 Champagne gold	太郎灰 Highclass grey	香槟金 Champagne gold	太郎灰 Highclass grey	
挂架 1000 杆 (带灯)/With lighting	4031103	4031105	古斯特 A 套餐 /GUSTA set A	4031011 4031021	1000mm
挂架 1000 杆 (不带灯)/Without lighting	4031102	4031104	古斯特 A 套餐 /GUSTA set A	4031011 4031021	1000mm



名称 Name	挂杆型号 Item No.(hanging bar)	名称 Name	套餐型号 Item No.(rack set)	长度 Length	
	香槟金 Champagne gold	太郎灰 Highclass grey	香槟金 Champagne gold	太郎灰 Highclass grey	
挂架 700 杆 (带灯)/With lighting	4031073	4031075	古斯特 B 套餐 /GUSTA set B	4031012 4031022	700mm
挂架 700 杆 (不带灯)/Without lighting	4031072	4031074	古斯特 B 套餐 /GUSTA set B	4031012 4031022	700mm



名称 Name	挂杆型号 Item No.(hanging bar)	名称 Name	套餐型号 Item No.(rack set)	长度 Length	
	香槟金 Champagne gold	太郎灰 Highclass grey	香槟金 Champagne gold	太郎灰 Highclass grey	
挂架 700 杆 (带灯)/With lighting	4031073	4031075	古斯特 C 套餐 /GUSTA set C	4031013 4031023	700mm
挂架 700 杆 (不带灯)/Without lighting	4031072	4031074	古斯特 C 套餐 /GUSTA set C	4031013 4031023	700mm



名称 Name	挂杆型号 Item No.(hanging bar)	名称 Name	套餐型号 Item No.(rack set)	长度 Length	
	香槟金 Champagne gold	太郎灰 Highclass grey	香槟金 Champagne gold	太郎灰 Highclass grey	
挂架 700 杆 (带灯)/With lighting	4031073	4031075	古斯特 D 套餐 /GUSTA set D	4031014 4031024	700mm
挂架 700 杆 (不带灯)/Without lighting	4031072	4031074	古斯特 D 套餐 /GUSTA set D	4031014 4031024	700mm

SUS304
不锈钢



型号 Item No.	名称 Name	宽度 x 深度 x 高度 Width x Depth x Height	材质 Material	表面 Surface
不锈钢挂架 C 套餐	多功能挂刀架	333x115x200mm	不锈钢/SUS304	拉丝/Wire drawing
4030010	单层带围栏调味品架	333x115x200mm	不锈钢/SUS304	拉丝/Wire drawing
Set C	方筒储物架	111x115x300mm	不锈钢/SUS304	拉丝/Wire drawing
	挂杆 (含封头)	904x16x40mm	不锈钢/SUS304	拉丝/Wire drawing



型号 Item No.	名称 Name	宽度 x 深度 x 高度 Width x Depth x Height	材质 Material	表面 Surface
不锈钢挂架 D 套餐	单层带围栏调味品架	333x115x200mm	不锈钢/SUS304	拉丝/Wire drawing
4030011	锅盖挂架	166x115x200mm	不锈钢/SUS304	拉丝/Wire drawing
Set D	五位挂钩	166.5x45x70mm	不锈钢/SUS304	拉丝/Wire drawing
	挂杆 (含封头)	904x16x40mm	不锈钢/SUS304	拉丝/Wire drawing



型号 Item No.	名称 Name	宽度 x 深度 x 高度 Width x Depth x Height	材质 Material	表面 Surface
不锈钢挂架 A 套餐	多功能挂刀架	333x115x200mm	不锈钢/SUS304	拉丝/Wire drawing
4030008	方筒储物架	111x115x300mm	不锈钢/SUS304	拉丝/Wire drawing
Set A	挂杆 (含封头)	604x16x40mm	不锈钢/SUS304	拉丝/Wire drawing



型号 Item No.	名称 Name	宽度 x 深度 x 高度 Width x Depth x Height	材质 Material	表面 Surface
不锈钢挂架 B 套餐	围栏调味品架	333x115x200mm	不锈钢/SUS304	拉丝/Wire drawing
4030009	五位挂钩	166.5x45x70mm	不锈钢/SUS304	拉丝/Wire drawing
Set B	挂杆 (含封头)	604x14x40mm	不锈钢/SUS304	拉丝/Wire drawing



型号 Item No.	名称 Name	宽度 x 深度 x 高度 Width x Depth x Height	材质 Material	表面 Surface	工艺 Process
4030012	多功能折叠挂架 /Folding hook	387x465x502mm	碳钢 /Carbon steel	金属灰 /Dark grey	纳米喷涂 /Dry plating



型号 Item No.	适用柜宽 (T) Cabinet width	宽度 x 深度 x 高度 Width x Depth x Height	材质 Material	表面 Surface	工艺 Process
3090002	300mm	264x500x580mm	碳钢 /Carbon steel	白色 /White	环保喷涂 /Environmental coating



WASTE CONTAINER 垃圾桶



型号 Item No.	适用柜宽 (T) Cabinet width	宽度 x 深度 x 高度 Width x Depth x Height	材质 Material	颜色 Color
3090003	300mm	250x455x355mm	塑料 / Plastic	深灰色 / Dark grey
3090004	300mm	250x455x355mm	塑料 / Plastic	深灰色 / Dark grey

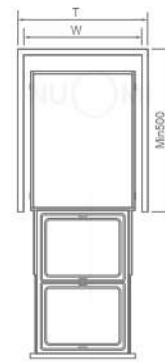

WASTE CONTAINER UNDER SINK 水槽柜垃圾桶



型号 Item No.	宽度 x 深度 x 高度 Width x Depth x Height	材质 Material	颜色 Color
3090005	370x270x320mm	塑料 / Plastic	灰色 / Grey

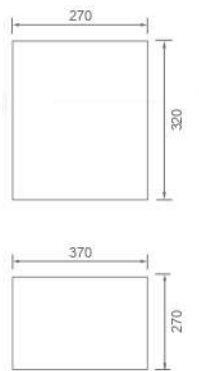

NUOMI KITCHEN
STORAGE SOLUTIONS

诺米厨房五金收纳解决方案

